

MANDÍK[®]

DISC VALVE
TVPM - TVOM

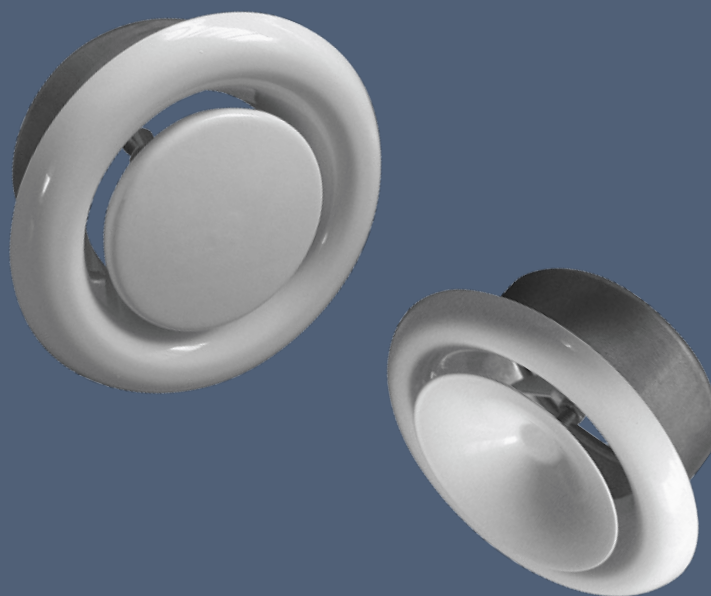

These technical specifications state a row of manufactured sizes and models of disk valves (further only valves) TVOM, TVPM. It is valid for manufacture, designing, ordering, delivery, assembly and operation.

I. CONTENT

II. GENERAL INFORMATION	3
1. Description.....	3
2. Design.....	3
3. Dimensions, weights.....	3
4. Placement and Assembly.....	5
III. TECHNICAL DATA	5
5. Basic parameters.....	5
IV. ORDERING INFORMATION	7
6. Ordering key.....	7
V. MATERIAL	8
7. Material.....	8
VI. INSPECTION, TESTING	8
8. Inspection, testing.....	8
VII. TRANSPORTATION AND STORAGE	8
9. Logistic terms.....	8
VIII. ASSEMBLY, ATTENDANCE, MAINTENANCE AND REVISIONS	8
10. Assembly.....	8

II. GENERAL INFORMATION

1. Description

- 1.1. Valves are end parts of ventilation or air conditioning systems. Valves TVPM are intended for air supply and TVOM are intended for air outlet. Amount of supplied or outlet air could be regulated by rotating disc of valve body. After taking out the valve body from the casing, the set upped position "s" is ensured by means of the check nut, and the valve can again be set into the casing. The bodies of the valves are set in casing and secured by bayonet closures.
- 1.2. Valves are designed for macroclimatic areas with mild climate according to EN 60 721-3-3.
- 1.3. Nozzles are suitable for systems without abrasive, chemical and adhesive particles.
- 1.4. If is not noticed other way, all dimensions and weight are in millimeters and kilograms.

2. Design

- 2.1. Valves can be delivered in the following versions:

- for air supply - TVPM
- for air outlet - TVOM

Fig. 1



3. Dimensions, weights

- 3.1. Valve dimensions and weights

Tab. 3.1.1. Dimensions and weights

Size	øD	øD ₁	ød ₁	ødp	ødo	L	L ₁	Set upped position with		Weight [kg]	
								TVPM	TVOM	TVPM	TVOM
80	115	105	79	80	60	42	50	9 to -3	12 to -15	0,150	0,125
100	138	125	99	93	75	40	50	10 to -3	10 to -10	0,190	0,170
125	164	150	124	115	99	46	50	15 to -7	9 to -17	0,270	0,230
150	202	175	149	135	118	50	50	15 to -5	10 to -15	0,390	0,350
160	211	185	159	148	129	54	50	15 to -10	5 to -20	0,420	0,380
200	248	225	199	196	157	63	50	20 to -3	20 to -25	0,590	0,510

3.2. Valve for air supply - TVPM

Fig. 2

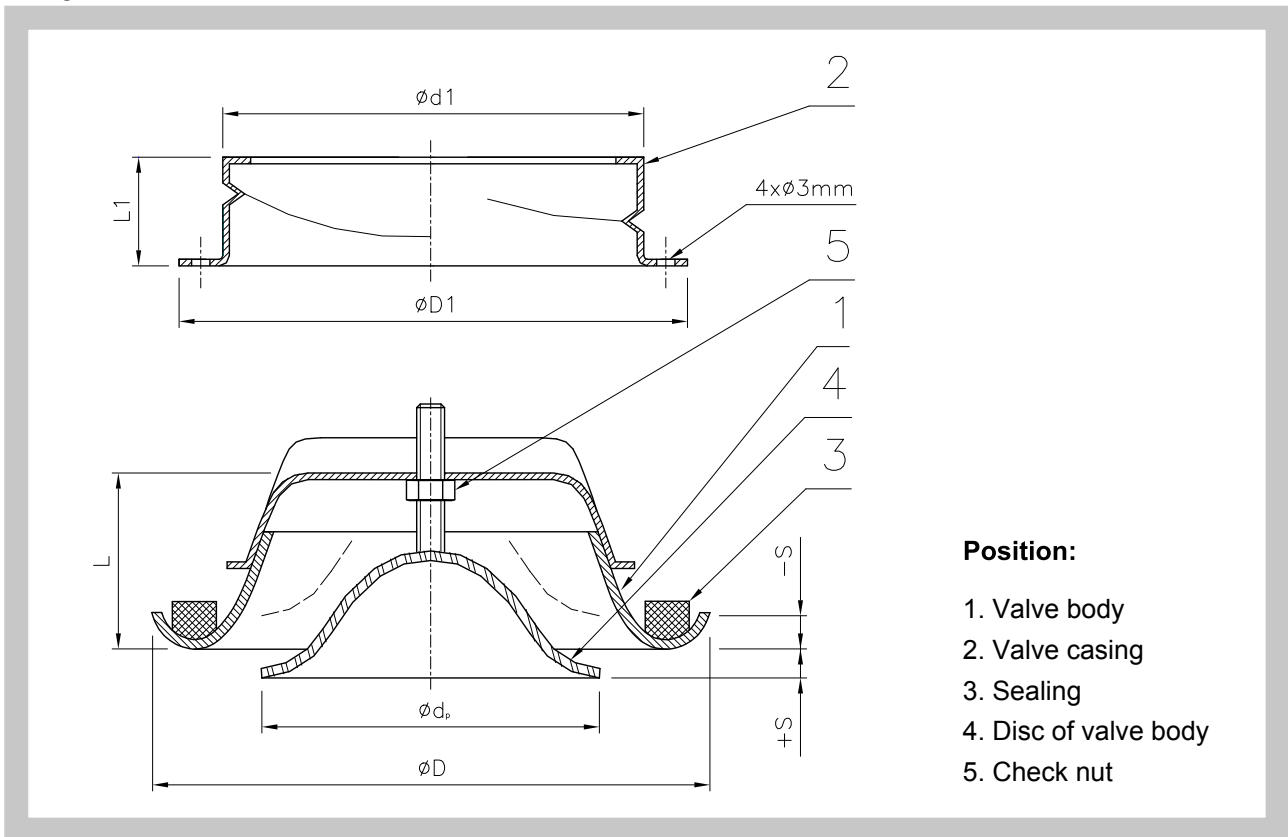

3.3. Valve for air outlet - TVOM

Fig. 3

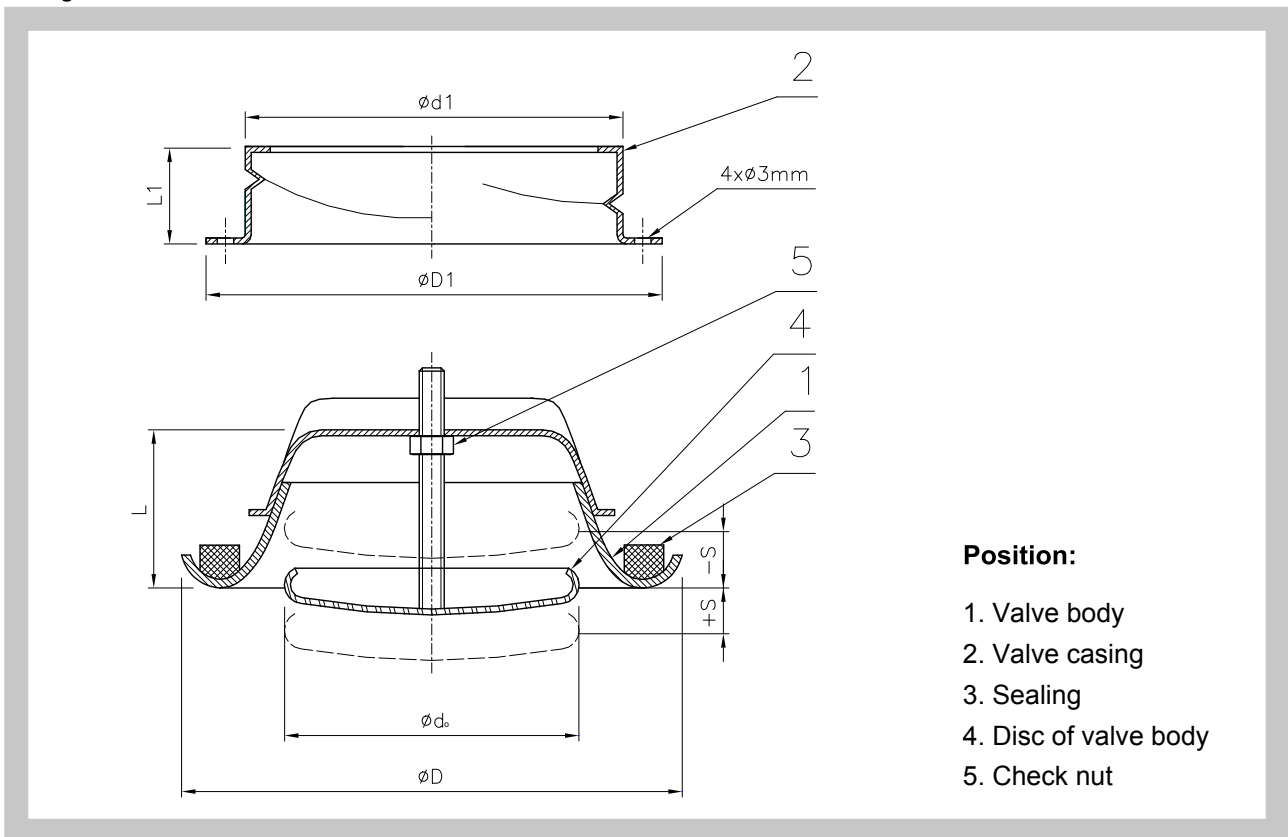

4. Placement and Assembly

- 4.1. Valves are installed in ceilings, walls and other constructions.
- 4.2. Valves have to be connected to straight duct section with length 250 mm to achieve equal flow through valve. It is valid for air supply and air outlet.

III. TECHNICAL DATA

5. Basic parameters

5.1. Basic data

- \dot{V} [m³.h⁻¹] volumetric air flow per one valve
- s [mm] distance of valve disc from zero position
- Δp_c [Pa] pressure loss at $\rho = 1,2 \text{ kg/m}^3$
- L_{WA} [dB(A)] level of acoustic power

Tab. 5.1.1. Valve for air supply - TVPM

Size	80	100	125	150	160	200
\dot{V}_{max} [m ³ .h ⁻¹]	60	90	150	200	200	250

Tab. 5.1.2. Valve for air outlet - TVOM

Size	80	100	125	150	160	200
\dot{V}_{max} [m ³ .h ⁻¹]	60	90	150	200	200	250

5.2. Pressure loss and sound data

5.2.1. Valve for air supply TVPM

Diagram 5.2.1. TVPM 80

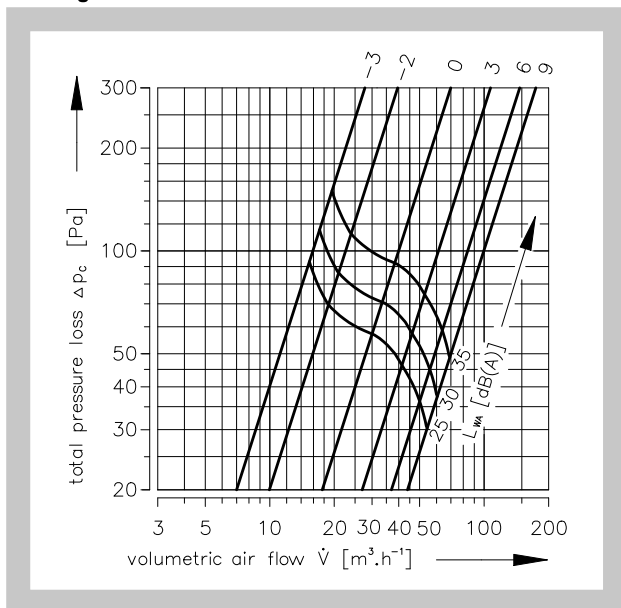

Diagram 5.2.2. TVPM 100

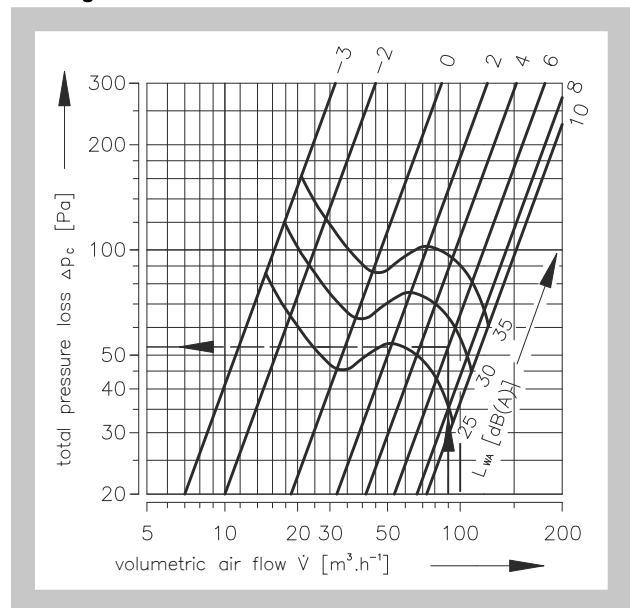

Diagram 5.2.3. TVPM 125

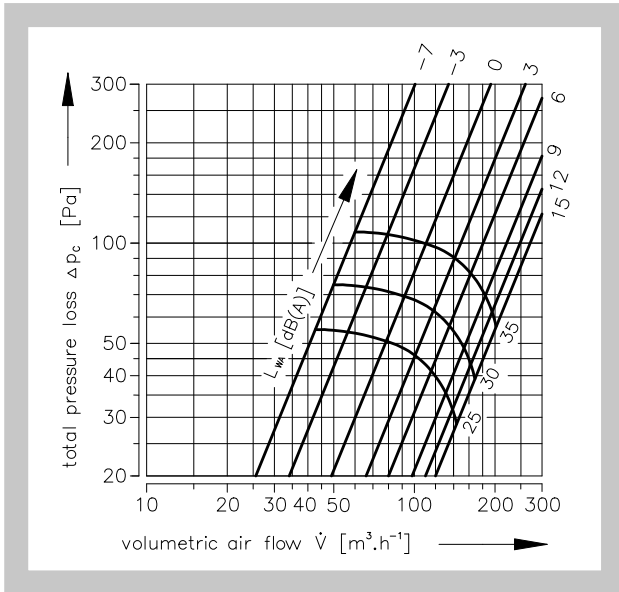

Diagram 5.2.4. TVPM 150

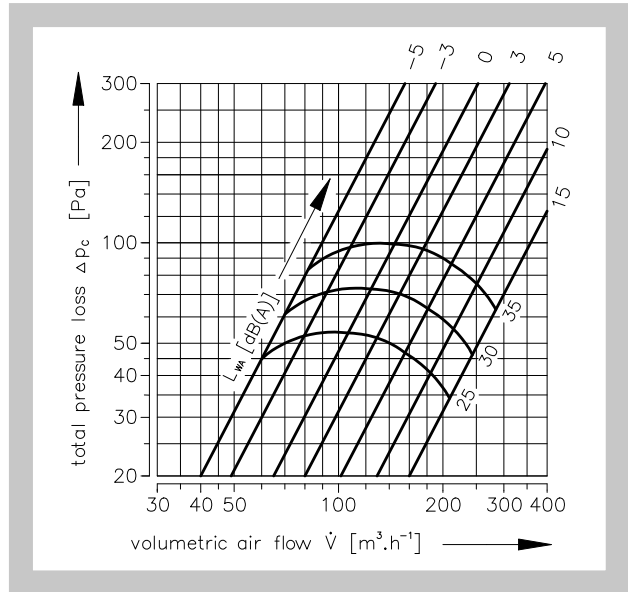

Diagram 5.2.5. TVPM 160

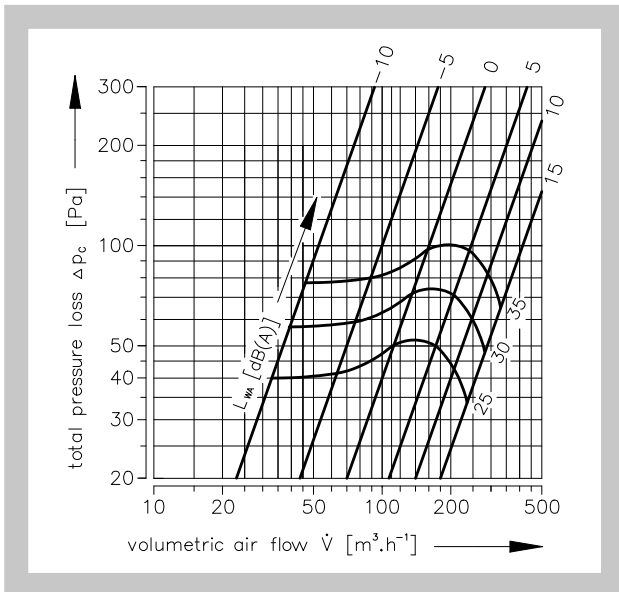
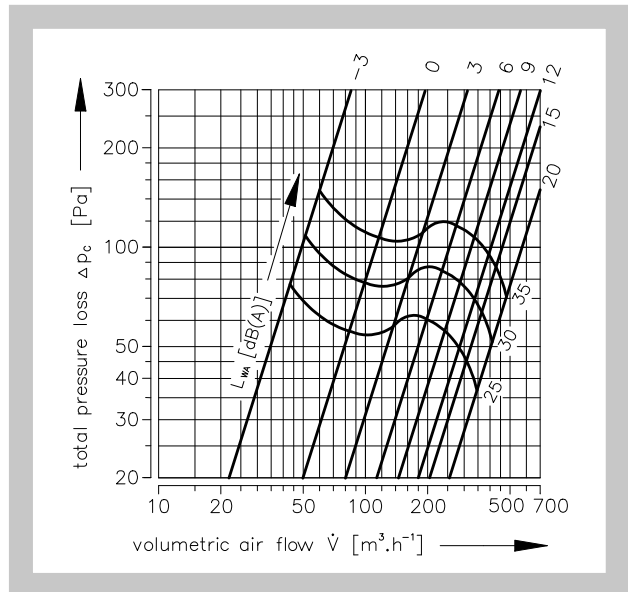

Diagram 5.2.6. TVPM 200



5.2.2. Valve for air outlet

Diagram 5.2.7. TVOM 80

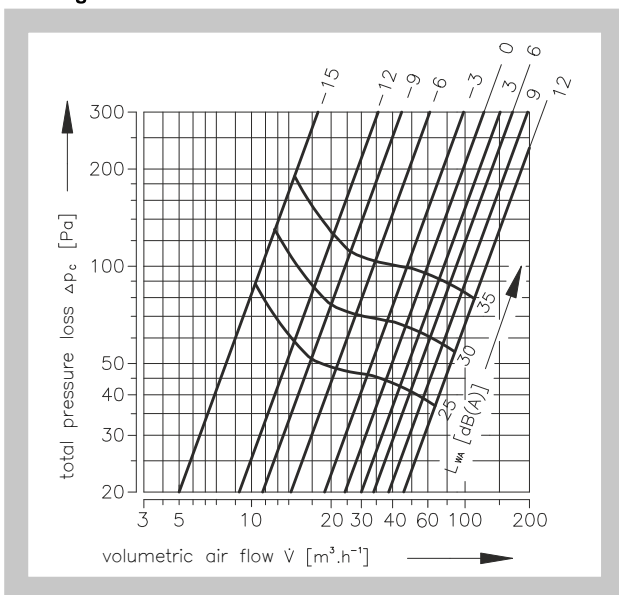

Diagram 5.2.8. TVOM 100

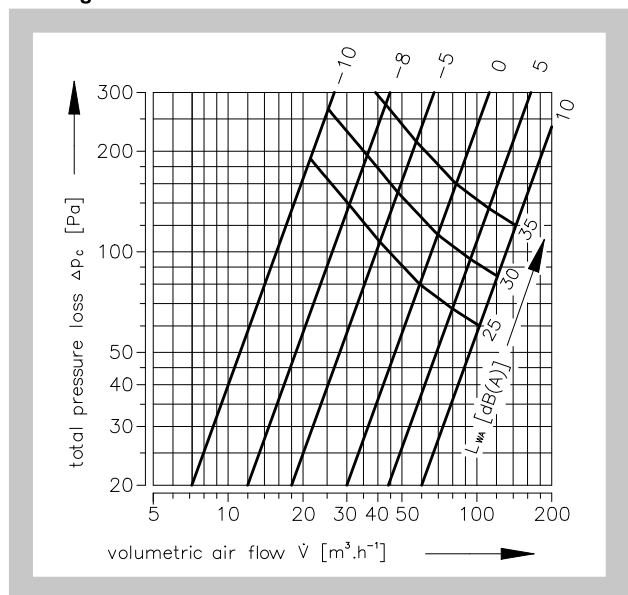

Diagram 5.2.9. TVOM 125

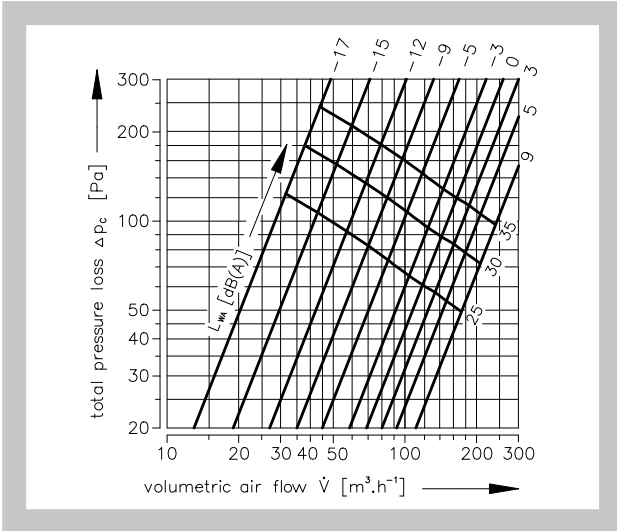

Diagram 5.2.10. TVOM 150

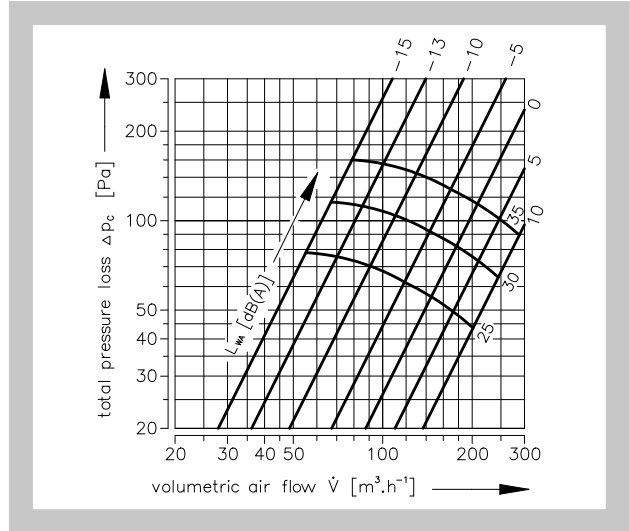

Diagram 5.2.11. TVOM 160

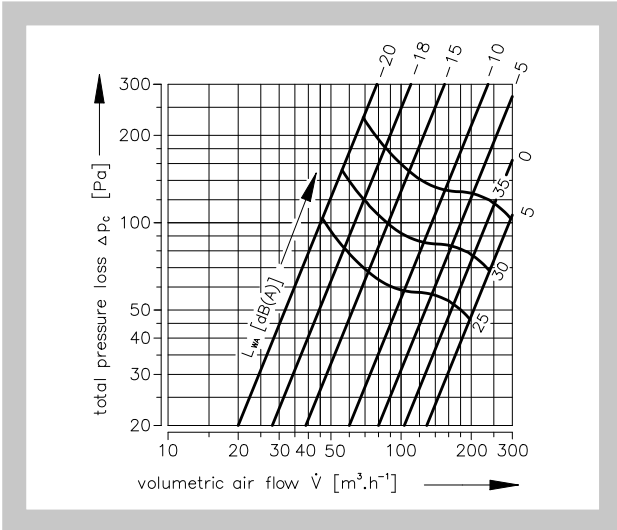

Diagram 5.2.12. TVOM 200

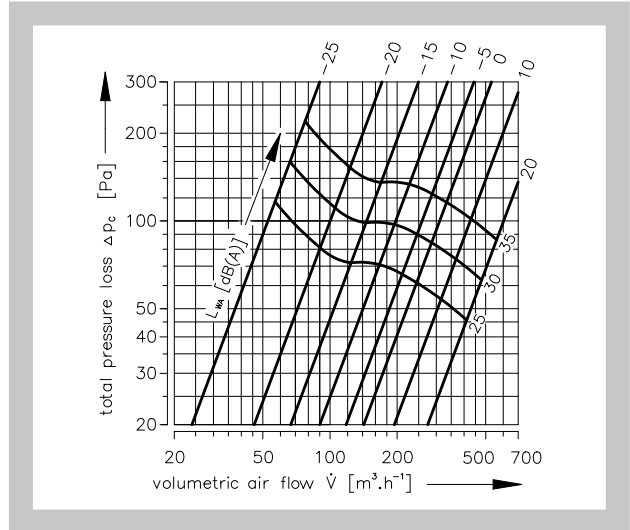

Fig. 4 Example

Given data:	Disc valve TVPM 100
	$\dot{V} = 90 \text{ m}^3 \cdot \text{h}^{-1}$
	$s = 6 \text{ mm}$
Diagram 5.2.2. :	$L_{WA} = 28 \text{ dB(A)}$
	$\Delta p_c = 43 \text{ Pa}$

IV. ORDERING INFORMATION

6. Ordering key

TVPM 100 TPM 028/03



V. MATERIAL

7. Material

- 7.1. Body and disc of valve are made of steel sheet covered by white color RAL 9010. Casing of valves are made of galvanized sheet.

VI. INSPECTION, TESTING

8. Inspection, testing

- 8.1. The appliance is constructed and preset by the manufacturer, its operation is dependent on proper installation and adjustment.

VII. TRANSPORTATION AND STORAGE

9. Logistic terms

- 9.1. Valves are supplied packed in carton packaging. While transported and stored they must be protected against mechanical damage and weather conditions.
- 9.2. If no method of take-over is mentioned in the order, handing the goods over to the carrier will be considered as a take-over.
- 9.3. Valves have to be stored in closed premises, in the environment without aggressive steams, gases and dusts. Temperature range have to be from -5 to +40°C and relative humidity max. 80%.

VIII. ASSEMBLY, ATTENDANCE, MAINTENANCE AND REVISIONS

10. Assembly

- 10.1. Assembly consists of the valve installing in the duct system.

MANDÍK, a.s.
Dobříšská 550
26724 Hostomice
Czech Republic
Tel.: +420 311 706 706
E-Mail: mandik@mandik.cz
www.mandik.com

The producer reserves the right for innovations of the product. For actual product information see
www.mandik.com