

MANDÍK®

INSTRUCTION FOR CONTROL OF MANDIK AIR-CONDITIONING UNIT THROUGH THE ROOM UNIT POL 822



CLIMATIX™

- Remote control of the air-conditioning unit of Mandík
- For use with Climatix controller
- Measurement of the room temperature
- Keys for switching on, adjustment of the room temperature set point, operating modes and fan control
- LCD display for showing the room temperature or selected temperature, operating modes, fan speed, current time, failure indication, etc.
- 2-wire interface to the controller
- Installation in all European flush-mounted recessed installation boxes

Use

The room unit is intended for basic users control and monitoring of the function of Mandík air conditioning units incl. basic parameters. The measurement of temperature of the room, where the room unit is installed, is integrated. Up to two room units can be connected to the Mandík measurement and control system. The room unit is not intended for setting the configuration parameters. The configuration parameters are set on the control panel of Climatic controller or through the web viewer of the computer connected to the Climatix controller installed in the switchboard with OS designation. The parameter setting is described in the document „Detailed instruction for control through HMI Climatix“.

Characteristics

The room unit is intended for semi-flushed surface mounting with a recessed installation box. The cable entry is through the rear of the unit.

The unit consists of a front cover with electronics and a rear cover. The rear cover can be removed after loosening the safety mechanism.

The front cover comprises a printed-circuit board and a room temperature sensor, an LCD panel and key buttons for selection of operating mode, temperature set-up, time setting and fan speed.







The rear cover includes terminal connections for connection of two-wire communication conductors. Both covers are made of plastic material.

Cover removal

The cover removal is described in the Installation manual that forms a part of the package.

Control buttons and display

Buttons

No.	Icon	Name	Function
1		ON/OFF	Button for switching on or off the air conditioning unit.
2		Occupancy	The button enables to switch on/off temporarily the occupancy mode in the time programme.
3		Parameters	The button enables to change the required temperature values or to quit the viewing of the actual temperatures.
4	-	Minus	The button for changing the set-point of the selected parameter or temperature.
5	+	Plus	The button for changing the set-point of the selected parameter or temperature.
6		Info	By pressing the button the viewing of current temperatures is activated or the possibility to change the required temperatures is quitted.
7		Fan	The button is used to set the fan speed within the pre-set fan speeds for the modes Economy and Comfort .
8		Mode	Using this button you can switch between the modes Time Schedule, Economy and Comfort , when the air conditioning unit is on.

Icons

No.	Icon	Meaning
1		Temperature in °C (resolution 0.1 °C).
		The temperature can be adjusted with a resolution of 0.5°C.
2		Time
3		Fan speed. Number of stages
4		Weekday indicator in the lower part of the display.
5		Modes are switched off – the air conditioning unit is off or it works in the complementary mode of room frost protection based on parameters in the room unit setting ^{*)} .
6		Automatic change of air conditioning unit modes according to the time schedule. It is not used, if no time schedule is available.
7		Economy mode - the air conditioning unit is on.
8		Comfort mode - the air conditioning unit is on.
9		Cooling is on; the flashing icon indicates a cooling failure.
10		Heating is on; the flashing icon indicates a heating failure.
11		Humidifying is on; the flashing icon indicates a humidifying failure.
12		Complementary mode is on; the flashing icon indicates the complementary mode failure.
13		Fans are on; the flashing icon indicates a fan failure.
14		Operation with the use of power-saving function of energy recovery and air mixing. The flashing icon indicates the failure of generator energy saving function.
15		Failure indication. The flashing icon indicates a new failure. The lighting icon indicates an extinct failure not confirmed/quitted by the operator or a failure that has been quit by the operator, but has not extinguished yet. Further details are given by flashing icons. The specific failure is displayed on the control panel of the Climatix controller or web viewer of the computer connected to the Climatix controller in the OS-designated switchboard.
16		Indication of non-standard operation or status of the air conditioning unit. The lighting icon indicates a non-standard operation, so-called non-serious failure (clogged filter, thawing air conditioning/condensing unit, etc.). The flashing unit indicates blocking of the air conditioning unit operation due to non-meeting of operating conditions (low temperature of heating water, etc.). The particular information is displayed on the control panel of the Climatix controller or web viewer of the computer connected to the Climatix controller in the OS-designated switchboard.

Starting the air conditioning unit Switch the air conditioning unit on or off by pressing the button **OFF/ON**.

When the air conditioning unit is switched on, the unit is in condition before last switching off (**Time Schedule, Economy or Comfort**). This condition is indicated by combination of icons 6, 7 and 8.

After switching off the air conditioning unit, the unit is either turned off or it changes over into complementary mode of room frost protection. This status is indicated by icon 5. In the default setting of the complementary frost protection mode, the air conditioning unit is turned off. Only if the room temperature falls below 5°C, the air conditioning unit is switched on until the room temperature higher than 5°C is reached. If the room temperature sensor is not used, it can be substituted by a temperature sensor of the supplied or exhausted air. The substitution is performed in configuration parameters^{*)}.

Operating mode selection

After switching on the air conditioning unit by the **OFF/ON** button and by pressing the button **Mode** the air conditioning unit switches between the modes **Time schedule, Economy** and **Comfort** in cycles. If no time schedule is set, the air conditioning unit switches only between the modes **Economy** and **Comfort**. The currently selected mode is indicated on the display by the combination of the relevant icons 6, 7 and 8.

Operating mode Economy

In the mode **Economy** the air conditioning unit is heating or cooling so that the temperature required for this **Economy** mode is reached. This mode is indicated on the display by the icon 7. The default setting for this mode is 18°C.

The current temperature can be changed temporarily by the **Plus** or **Minus** buttons. The temperature setting can be changed by the **Parameters** button.

The fan speed is preset in the configuration parameters of this mode^{*)}. The speed can be increased by the button **Fans** in six steps up to the speed corresponding to the **Comfort** mode. This setting is possible only if the configuration parameters are adjusted for fan button control^{*)}.

Operating mode Comfort

In the mode **Comfort** the air conditioning unit is heating or cooling so that the temperature required for this **Comfort** mode is reached. This mode is indicated on the display by the icon 8. The default setting for this mode is 22°C.

The current temperature can be changed temporarily by the **Plus** or **Minus** buttons. The temperature setting can be changed by the **Parameters** button.

The fan speed is preset in the configuration parameters of this mode^{*)}. The speed can be reduced by the button **Fans** in six steps down to the speed corresponding to the **Economy** mode. This setting is possible only if the configuration parameters are adjusted for fan button control^{*)}.

Complementary modes

Complementary modes are activated when the operating modes **Comfort** and **Economy** are deactivated. Upon activation of the complementary mode, the air conditioning unit is switched on so that the quality of the air conditioning unit operation is improved with regard to the conditioned room, i.e. to avoid unnecessary cooling down or overeating of the conditioned room in the period when the operating modes **Economy** and **Comfort** are deactivated. The complementary modes can also function as protection of the equipment and the conditioned room. These complementary modes are activated in the configuration parameters^{*)}.

Time schedule

The selection of **Time Schedule** is indicated on the display by the icon 6. When you select this mode, so the controller switches between the modes according to the time schedule adjusted. The modes **Economy** and **Comfort** are again indicated by the icons 7 and 8 together with the icon 6. The switched-off modes (complementary frost protection mode) are indicated by icon 6 only.

Temporary change of the modes in the time schedule can be performed by the **Occupancy** button. The temporary change is indicated by the flashing icon 6 and the icon of the active mode. This temporary change will last until the next change of the mode according to the time schedule.

The fan speed can be changed in the time schedule by the button **Fans** in six steps within the speed ranges preset for the modes **Economy** and **Comfort**, if the configuration parameters enable to control the speed from the room unit.

Temperatures for the modes **Economy** and **Comfort** controlled according to the time schedule cannot be changed from the room unit as they are also controlled according to the time schedule or configuration parameters^{*)}.

The time schedule can be programmed for the whole year. The individual points of the time schedule are set on the control panel of the Climatix controller or through the web viewer of the computer connected to the Climatix controller in the OS-designated switchboard. The time schedule setting is described in the document „Detailed instruction for control through HMI Climatix“.

Description of individual functions

Setting the required temperature for **Comfort** mode

There are two ways to set up the temperatures required for the **Comfort** mode outside the time schedule (only the icon 8 is on). Temporary temperature setting, until the next change of mode, or permanent temperature setting. The temporary temperature setting is made by the buttons **Plus** or **Minus** when the **Comfort** mode is active. To set the temperature permanently, press the button **Parameters**, an image with the parameter **Comf** and the flashing required temperature for the **Comfort** mode are displayed. Change the temperature to the required value using the **Plus** or **Minus** buttons. The setting is quitted by the **Info** button or automatically after 30 seconds of inactivity.

Setting the required temperature for *Economy* mode

There are two ways to set up the temperatures required for the *Economy* mode outside the time schedule (only the icon 7 is on). Temporary temperature setting, until the next change of mode, or permanent temperature setting. The temporary temperature setting is made by the *Plus* or *Minus* buttons when the *Economy* mode is active. To set the temperature permanently, press 2x the button *Parameters*, an image with the parameter *Econ* and the flashing required temperature for the *Economy* mode are displayed. Change the temperature to the required value using the *Plus* or *Minus* buttons. The setting is quitted by the *Info* button or automatically after 30 seconds of inactivity

Information viewing

By pressing the *Info* button the image with the information values from the connected temperature sensors, air humidity or quality sensors occurs in dependence on the current configuration of the air conditioning unit. These values are displayed in cycles and the next value is displayed by repeated pressing the *Info* button.

The values below are available:

Zad – required temperature °C

Dod – temperature of the air supplied °C

Pro – room temperature °C

Ven – outdoor temperature °C

VoT – temperature of heating water on the return pipe °C

VoC – temperature of the cooling water on the return pipe °C

Spa – temperature of the waste gases of gas heating °C

Odv – temperature of exhaust air °C

Rek – temperature behind the recuperator °C

Chl – temperature behind the cooler °C

Ohr – temperature behind the heater °C

Vlh – air humidity %

Kval – air quality %

The information viewing is quitted by the *Parameters* button or automatically after 30s of inactivity.

Fan speed

The fan speed is set by the repeated pressing the button *Fans* provided that the configuration parameters^{*)} are preset to enable the control of the fan speed from the room unit. The fan speed can be set in six steps indicated on the display within ranges preset for the modes *Economy* and *Comfort*. The fan speed for the individual modes is set in the configuration parameters^{*)}.

If the fan speed control from the room unit is not enabled, then the icon 3 shows the fan speed determined by the Climatix controller according to the current operating mode.

The fan speed setting is purposeful only if the fan motors are controlled by the frequency converter or if EC motors are used.

The fan operation is indicated on the display by the icon 13, in case of fan failure the icon is flashing.

Button locking

The button locking is used to protect the setting from the unauthorized intervention by a non-instructed person. The lock is activated by pressing and holding the button **Occupancy** (for approx. 8s). The lock is indicated on the display by the notice **"LOCK"**. In this condition, no changes of values or modes are possible. When you press any button on the display, the notice **"LOCK"** occurs on the display. The buttons are unlocked again by pressing and holding the button **Occupancy**. The unlocking is indicated on the display by the notice **"OPEN"**.

Room unit reset

The room unit can be reset by pressing and holding the button **Fan** (approx. 8s). Upon pressing this button, the display goes out and new initialization is started and the communication is resumed.

System time

The correct system time setting is necessary for the correct function of the air conditioning unit according to the time schedule. The system time setting is activated by pressing and holding the button **Parameters**. The time can be changed by the **Plus** or **Minus** buttons and confirmed by the **Info** button. The setting sequence of the values of the system time changes in cycles and is as follows:

Hour → **minutes** → **time format** → **year** → **month** → **day** → **hour...**

The setting is quitted by pressing the button **Parameters** or after inactivity exceeding 30s.

The system time can also be set on the control panel of the Climatic controller or through the web viewer of the computer connected to the Climatix controller in the OS-designated switchboard. The system time setting is described in the document „Detailed instructions for control through HMI Climatix“.

Communication

The parameters of the Climatix controller are factory-preset so that communication is established as soon as the room unit is connected to the controller. The parameter initialization is indicated on the display by the letter **P-**. The communication parameters can be set both on the Climatix controller and the room unit. When two room units are used, it is necessary to change the parameter **007** in one of the room units. The access code is „0000“ and is preset. The communication parameter can be changed as follows:

Press the buttons **OFF/ON**, **Mode**, **Plus** and **Minus** at the same time to activate the entry of the four-digit access code. The cursor is blinking at the first position and by repeated pressing the **Mode** button the first flashing parameter **001** is displayed. Using the **Plus** and **Minus** buttons select the flashing parameter to be changed and confirm the setting by the **Mode** button. The cursor jumps to the value below, which can be also changed by **Plus** and **Minus** buttons. The setting is again confirmed by the **Mode** button and the setting of all communication parameters is quitted by repeated pressing the **OFF/ON** button.

Number	Parameter description
001	KNX communication Communication is functioning - <i>OK</i> Communication is not functioning - <i>NG</i>
002	Individual address - (X.1.1) The range is 0 to 15. The preset value is 0.
003	Individual address - (1.X.1) The range is 0 to 15. The preset value is 1.
004	Individual address - (1.1.X) The range is 1 to 252. The preset value is 1.
005	Byte address - (X.1.1) The range is 1 to 126. The preset value is 5.
006	Room address – (1.X.1) The range is 1 to 14. The preset value is 1.
007	Zone address - (1.1.X) The range is 1 to 15. The preset value is 1.
008	Enable the network failure detection Enables or disables the detection of the communication network failure. The failure is indicated by a blinking notice “NET”.
009	Automatic assignment of the individual address 0 – the room unit uses the defined fixed individual address. 1 – the room unit generates automatically the individual addresses.

Note¹⁾

The configuration parameters are set on the control panel of the Climatix controller or through the web viewer of the computer connected to the Climatix controller in the OS-designated switchboard. The parameter setting is described in the document „Detailed instructions for control through HMI Climatix“.

Designing

The room unit is supplied from the connected controller through 2-wire interface (low voltage, SELV).

The room unit must be connected to the Climatix controller by two-wire twisted pair cable. It is possible to use unshielded conductors.

Mounting instructions

- The device is suitable for semi-flush mounting with a recessed installation box.
- The device must not be mounted into recesses, shelves, behind curtains or doors or above or near the direct heat sources.
- Avoid direct sun and draught.
- The conduit must be sealed on the device side as an air stream along the conduit can affect the sensor readings.
- The permissible ambient conditions for mounting the device must be observed.
- The mounting instructions are enclosed with the device.

Installation



Warning

Local installation regulations must be observed.

The equipment is not protected against accidental connection to AC 230 V.

Commissioning

Device connection

After interruption of the connection to the 2-wire interface, the communication is re-established only if the room units send a query about the controller address.

For QAA07, the time cycle for querying is: 250 ms

Step	Function	Description
1	LCD test	All display segments are displayed for approx. 2 seconds
2	Identification of the connected controller	The room unit establishes contact with the connected Climatix controller
3	Ready for operation	

Disposal



The device contains electrical and electronic components and must not be disposed as domestic waste.

The valid local legal regulations are to be observed!

Technical data

Supply voltage	Operating voltage	DC 12...15 V	
	the room unit is supplied from the connected controller via 2-wire interface (SELV, extra low voltage according to HD384)		
	Power consumption (from the controller)	Max. 0.22 VA	
Operating conditions	Temperature sensor		
	Measuring element	NTC resistance sensor	
	Measuring range	0...40 °C	
	Response	≤ 10 min	
	Accuracy (5 ... 30 °C)	± 1.0 K	
	Accuracy (25 °C)	± 0.5 K	
Display	Type	LCD	
	Display function	<ul style="list-style-type: none"> - Requirement adjustment - Operating mode selection - Manually selected fan speed - Control sequence - Time and weekday - Parameter setting (only when selected) 	
Interface	Type of interface between the controller and the room unit	2-wire interface connection	
	Voltage signal, logic 0	< 5 V	
	Voltage signal, logic 1	> 7 V	
	Maximum number of controllers	8	
	Baud rate	4.8 kbps	
Cable connection	Connection terminals (screw terminals)	Solid or stranded conductors 0.8...2.5 mm ²	
	Cable type	2-wire, twisted pair, unshielded	
	Max. distance between two units	75 m	
	Max. total busbar length	125 m	
Degree of cover protection	Protection according to EN 60529	IP 30	
Protection class	Protection class	III	
Ambient conditions	IEC 721-3	Operation	Transport
	Ambient air	class 3K3	class 2K3
	Temperature	+ 5...40 °C	- 25...70 °C
	Humidity	< 85% r.h.	< 93% r.h.
	Mechanical conditions	class 3M1	class 2M2
Industry standards	Electromagnetic compatibility		
	Immunity for residential, commercial and light-industrial environments	EN 61000-6-1:2001	
	Emission standard for residential, commercial and light-industrial environments	EN 61000-6-3:2001+A11:2004	
	CE conformity		

Make yourself familiar with the requirements for CE marking as defined in the EMC directive

2004/108/EC

Dimensions	See: "Dimensions"	
Colour	Front cover, rear cover, buttons	RAL9003 – white
Weight	Without packaging	0.12 kg

Electric connection

Terminal layout:

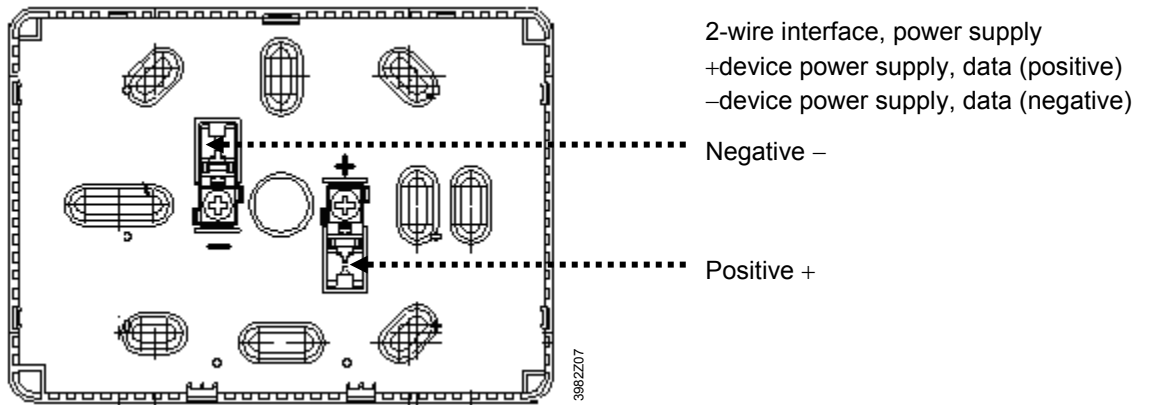

Dimensions (units: mm)

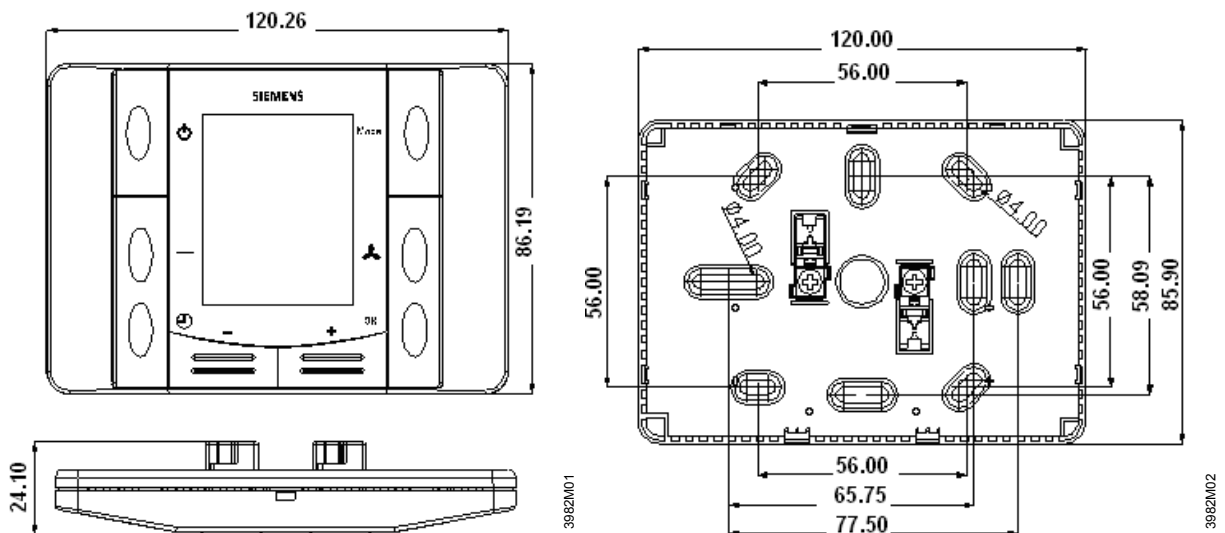

Connection of the room unit to the Climatix controller

