

# MANDÍK<sup>®</sup>

## Electronic control system MCS-P

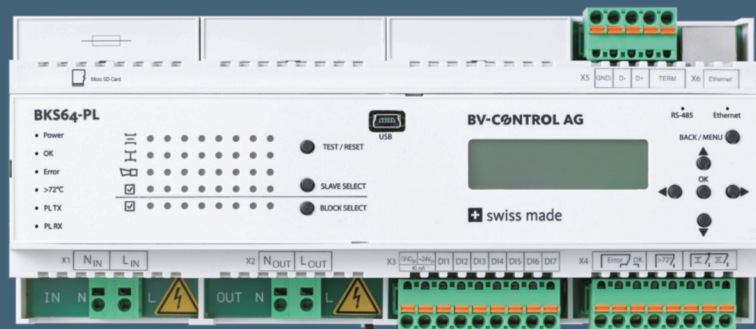



# Content

<b>1. General description</b> .....	<b>4</b>
<b>2. Central control unit BKS64-PL</b> .....	<b>5</b>
2.1 Technical parameters.....	7
2.2 Recommended use.....	7
2.3 Device description.....	8
2.4 Dimensions.....	8
2.5 Powerline communication .....	9
2.6 Electrical installation.....	10
2.7 Operation.....	11
2.8 Configuration and diagnostics software CDU .....	12
2.8.1 Event-logging .....	13
2.9 Commissioning .....	14
2.10 Automatic addressing.....	15
2.11 Testing and indication of the dampers.....	16
2.12 Selecting an interface .....	17
<b>3. Communication module BKN230-24-PL</b> .....	<b>18</b>
3.1 Technical parameters.....	19
3.2 Cable specification .....	20
3.3 Dimensions.....	20
3.4 Device description.....	21
3.5 LED indication .....	22
3.6 Test button.....	22
3.7 Error list .....	23
3.8 Smoke detector.....	23
<b>4. Safety instructions</b> .....	<b>24</b>

# 1. General description

This system is used to monitoring and control up to 64 motorized fire dampers and is compatible with all standard 24V actuators. The system consists of communication and from a central control unit that communicates with individual communication modules via powerline technology. That means communication through 230 VAC power cable, there is no need for any additional cable for data. The entire system operates on the Master & Slave principle, where the communications modules (Slaves) have a MAC address automatically set, the superior central control unit (Master) automatically detects individual modules and no further adjustments are required.

Powerline communication technology basically allows you to select any topology of a wiring, such as a star, line, bus or tree. For all topologies, however, the same limitation applies, and that the maximum distance from the master to the farthest communication module is 1200m. The picture shows an example of wiring an extended bus topology.

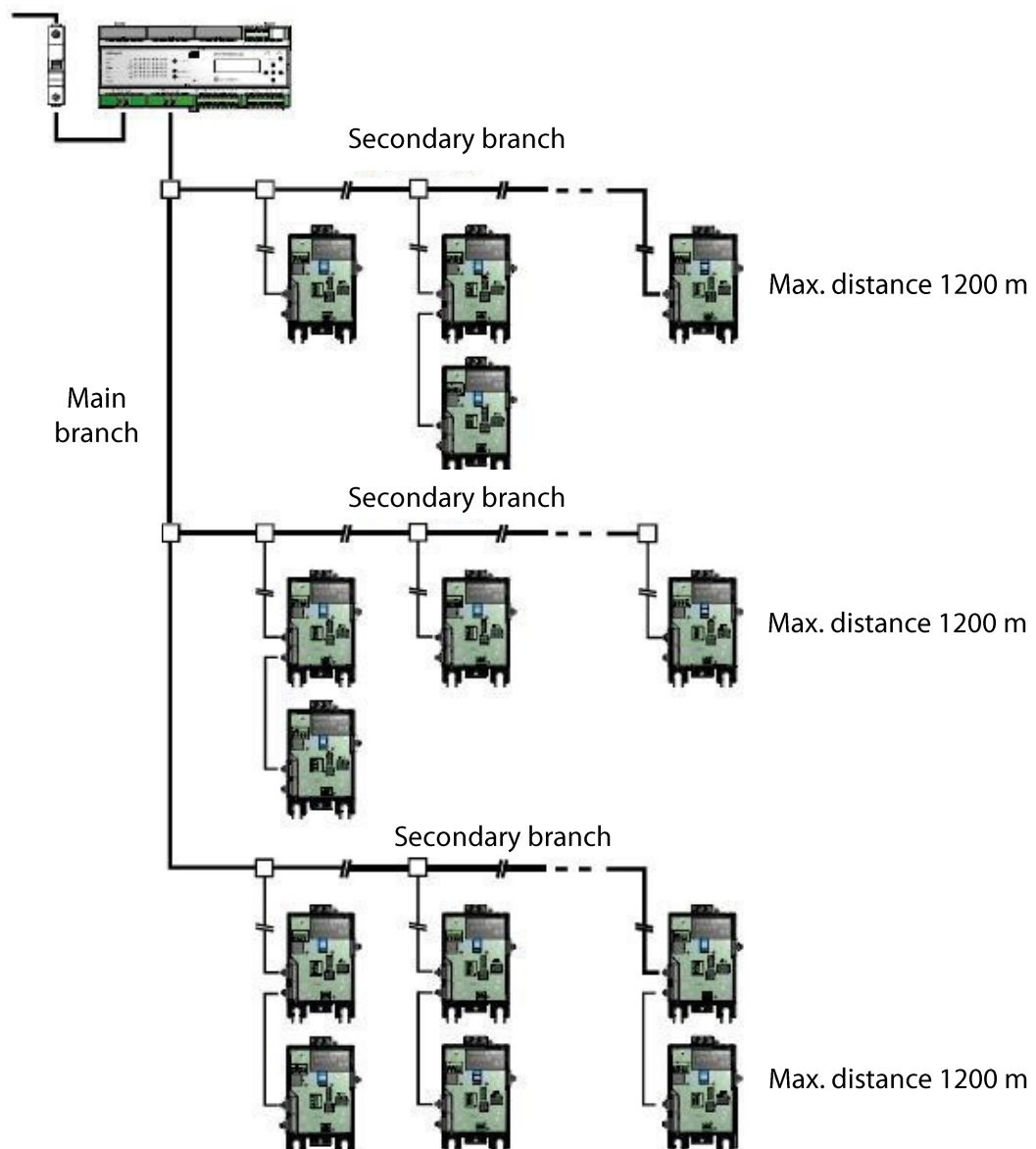

## 2. Central control unit BKS64-PL

BKS64-PL is a control and indication device for motorized fire dampers that can control up to 64 BKN230-24-PL communication modules. In total, it can monitor up to 64 motorized fire dampers and 64 smoke detectors in any topology. The system uses powerline technology, communication with the communication modules directly via a 230V AC power cable. Communication modules (BKN230-24-PL) have a unique physical MAC address and are therefore automatically recognized. The position of the damper and any eventual failures are displayed directly on the device. The damper can be selected and tested by pressing the button. The dampers can be opened or closed with a potential-free contact or an external + 24V AC / DC voltage source. Master (BKS64-PL) can also be controlled by Modbus (TCP / IP and RTU) or BACnet (IP or MS / TP) protocol, so it can be considered as Modbus / Powerline or BACnet / Powerline gateway. The device can be connected to a computer via ethernet or USB interface and controlled by the CDU software.

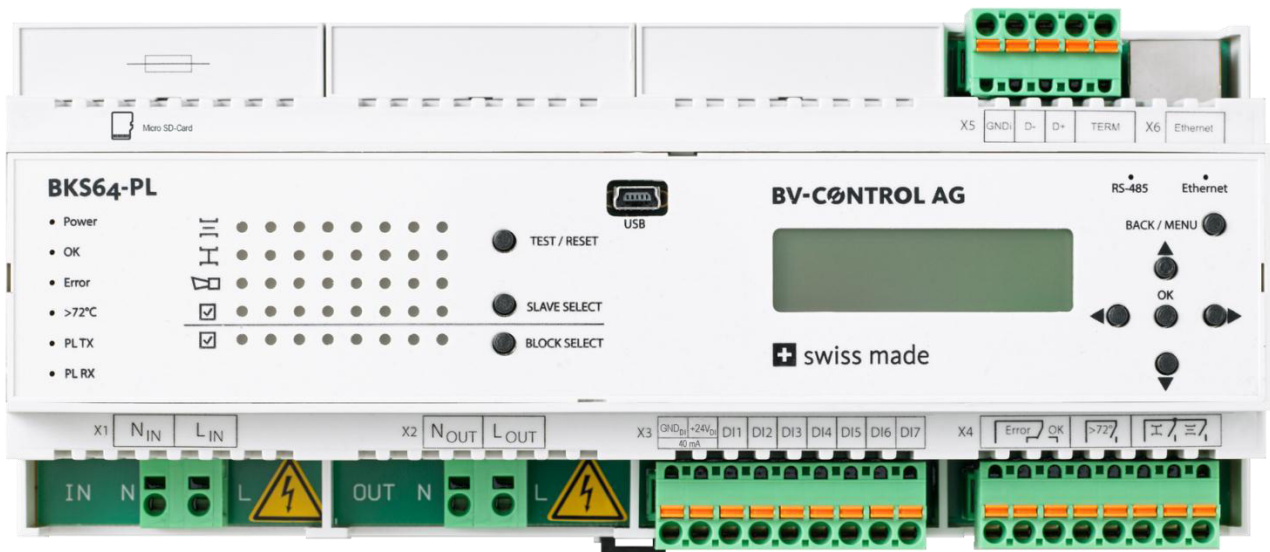

## 2.1 Technical parameters

<b>Electrical parameters</b>	Nominal voltage	230 V AC, 50/60 Hz
	Power consumption	8 W
	Dimensioning	120 VA + slave + actuator
	Connection	Spring connectors
	Relay load	0,5 A at 48 V AC; 1 A at 24 V DC
	Inputs	Type: Optocoupler 6 mA at 24 V DC (common ground)
	Auxiliary voltage	24 V DC at max. 40mA, galvanically isolated
	USB interface	Mini-USB, galvanically isolated
<b>Powerline communication</b>	Frequency	Frequency 1: 80 kHz... 167 kHz Frequency 2: 110 kHz... 197 kHz
	Modulation	PSK
	Baud rate	Max. 28,8 kbps
	Reception sensitivity	Max. 36 dB $\mu$ V
	Number of slaves	Max. 64
	Max. distance from master to BKS	Range: max. 1200 m from start to end
<b>Powerline filter</b>	Typical cycle time with 64 slaves	2,6s to 6,4s
	Damping	> 100 dB at 100 kHz
<b>Modbus RTU BACnet MS/TP (default)</b>	Medium	RS-485, galvanically isolated
	Formats for converting	1-8-N-2, 1-8-N-1, 1-8-O-1 (start bit, data bits, parity, stop bits)
	Baud rate	9600, 19200, 38400, 76800 bps
	Addresses	1 to 247 (0 reserved for broadcast)
	Termination	150 $\Omega$ switchable by wire bridge
	Typical response time	< 10 ms (delay switchable)
	Parameterization	Via CDU (Configuration and diagnostic tool) or directly on the device
<b>Modbus TCP / IP BACnet IP</b>	IP Static assignment	Static or DHCP, default: 10.0.0.2
	Configuration	Via CDU or directly on the device
<b>Security</b>	Class of protection	II
	EMC Low Voltage Directive	CE according to 2014/30/EU CE according to 2014/35/EU
	Operation	Type 1 (EN 30730-1)
	Ambient temperature	-30°C to +50°C
	Storage temperature	-30°C to +80°C
	Humidity test	95%, non-condensing (EN 60730-1)
	Maintenance	Maintenance free
<b>Mechanical parameters</b>	Width	212,1 mm
	Height	94 mm
	Depth	58 mm
	Weight	Approx. 465 g
	Mounting	On DIN 35 mm

## 2.2 Recommended use

The superior system BKS64-PL (master) has an internal filter that blocks interference from the network and prevents the powerline from entering the network. Parallel operations with multiple superior systems are therefore possible without the need for an additional filter. Since the signals from the electrical network can be inductively or capacitively transmitted over the line to the neighboring systems, different communication channels should be used on different devices.

Central control unit BKS64-PL has an internal fuse 10 A, nevertheless a circuit breaker 13A (<32 communication modules) or 16A (> 32 communication modules) with a characteristic D or a circuit breaker for devices with larger switching current should be installed in front of the device.

In the event of a short circuit in remote slaves, such as a poor connection, it may happen that the current of the circuit breaker may not be reached. In this case, the circuit breaks the BKS64-PL directly. Due to the high apparent power caused by the internal filter, a current of approximately 0.5A flows through the device, without the connected slaves. Through the system with 64 slaves and closed dampers must flow below 1.8A.

## 2.3 Device description

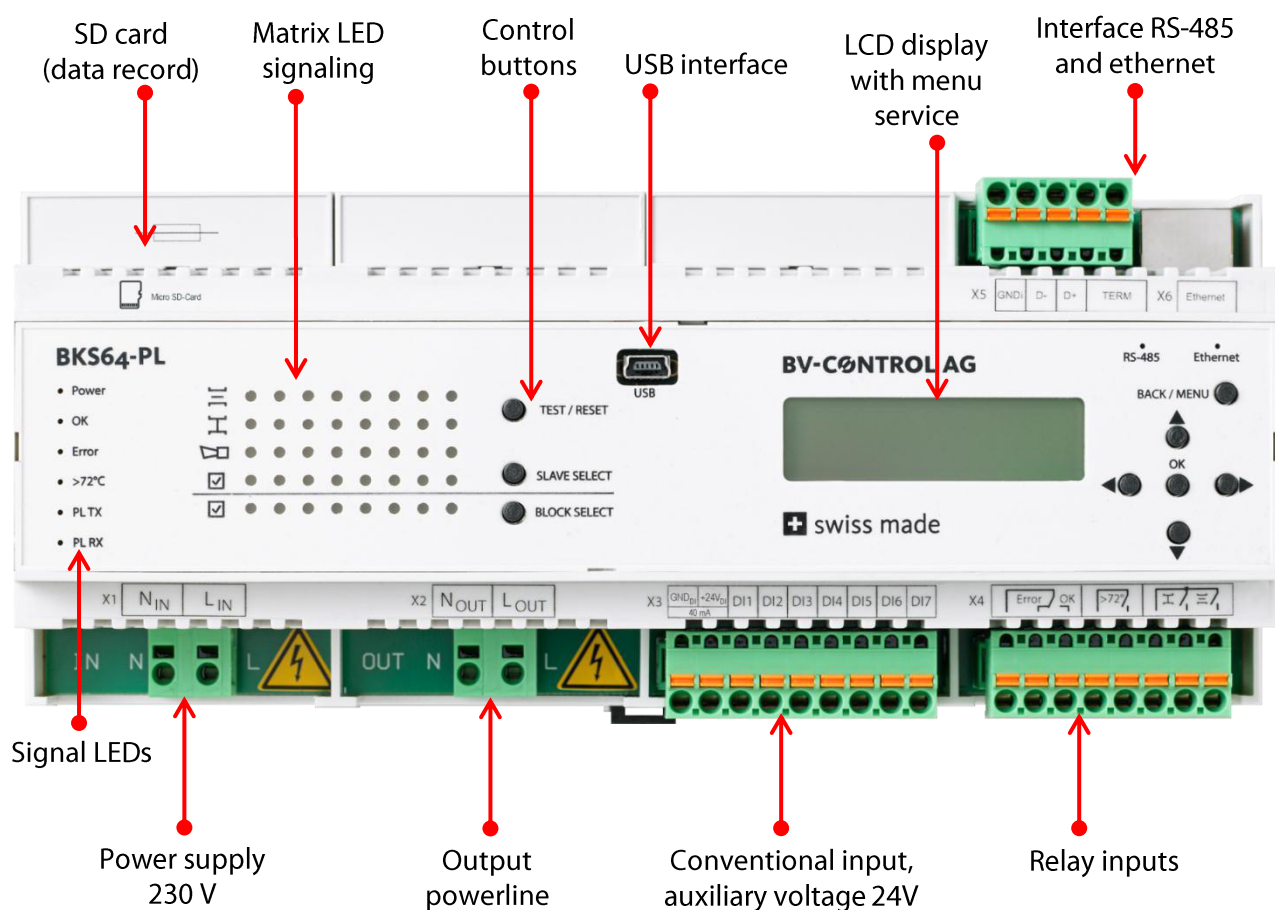

## 2.4 Dimensions

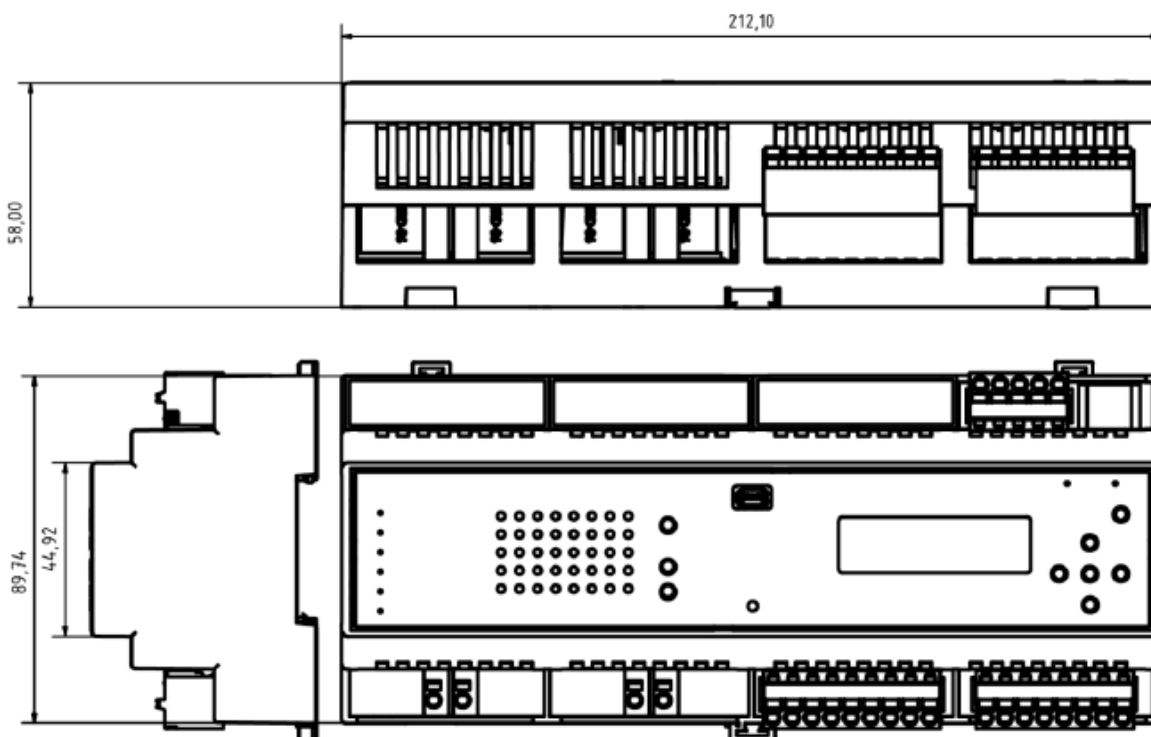



## 2.5 Powerline communication

Communication with slaves is via digital phase modulation (Phase-Shift-Keying) simultaneously on two frequencies. Depending on the quality of communication with individual communication modules, each master can automatically select between different types of modulation (B-PSK, Q-PSK, 8-PSK). In the case of a seriously impaired connection, it is also possible to communicate only after the phase transition to zero. After the channel has been changed, the device must be turned off and on, the channel automatically communicating to the connected slaves after the system restarts. Both communication frequencies are defined by the communication channel according to the following table:

<b>Canal</b>	<b>Frequency 1 [kHz]</b>	<b>Frequency 2 [kHz]</b>
1	80	110
2	83	113
3	86	116
4	89	119
5	92	121
6	95	124
7	98	127
8	101	130
9	104	133
10	107	137
11	140	170
12	143	173
13	146	176
14	149	179
15	152	182
16	155	185
17	158	188
18	161	191
19	164	194
20	167	197

## 2.6 Electrical installation

### X1 Power supply

Spring connector for the installation cable 230 VAC, 2 x 2,5 mm<sup>2</sup>

X1.1 neutral

X1.2 phase

### Fuse

13 A, characteristic C for less than 32 BKN230-24-PL

16 A, characteristic C for more than 32 BKN230-24-PL

### X2 Output powerline

Spring connector for the installation cable 230 VAC

Cross section 1,5 mm<sup>2</sup> for less than 32 BKN230-24-PL

Cross section 2,5 mm<sup>2</sup> for more than BKN230-24-PL

X1.1 neutral

X1.2 phase

### **Warning**

Wrongly connected cable can greatly affect communication and destroy Master or Slaves.

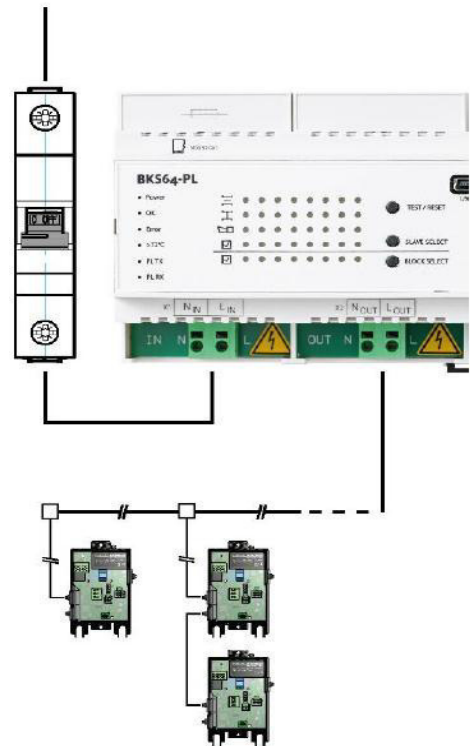

### X3 Auxiliary voltage (galvanic isolation) and optocoupler inputs

X3.1 GND<sub>DI</sub> (common GND)

X3.2 +24V<sub>DI</sub> with load max. 40 mA (use only for inputs DI1 at DI7)

X3.3 DI1, damper control

+24 VAC / VDC: Damper open

0V / open contact: Damper closed

X3.4 DI2, test / reset

+24 VAC / VDC: Reset error or test of damper

X3.5 DI3, BUS released

+24 VAC / VDC: BUS control enabled

0V / open contact: Control possible via DI1 / DI2,

Bus control is ignored

Bus tracking possible

X3.6 DI4 Reserved (polling via bus possible)

X3.7 DI5 Reserved (polling via bus possible)

X3.8 DI6 Reserved (polling via bus possible)

X3.9 DI7 Reserved (polling via bus possible)

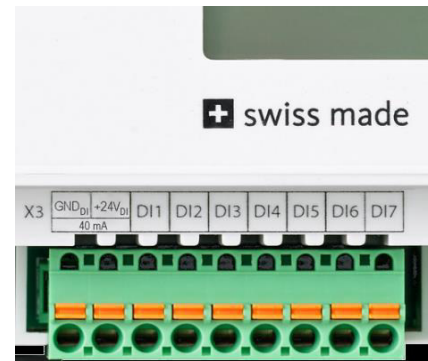

### X4 Relay outputs (switch contact)

X4.1 COM

X4.2 Summary errors

X4.3 Everything is OK (system ON)

X4.4 COM

X4.5 Fire alarm (thermal or smoke detector)

X4.6 COM

X4.7 Dampers are closed

X4.8 Dampers are open



### X5 RS-485 (3-wire, insulated)

X5.1 GNDi (insulated GND, grounding on the main side)

X5.2 D-

X5.3 D+

X5.4 Terminating resistor 1

X5.5 Terminating resistor 2 (set the jumper to X5.4 to adjust terminating resistor)

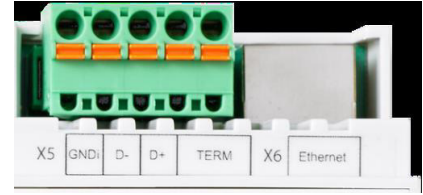

Interface parameters (baud rate, number of start and stop bits and parity) and addresses are defined using the configuration tool or menu.

Supported protocols: MODBUS RTU a BACNet MS / TP

### X6 Ethernet

An IP address can be automatically acquired via DHCP or statically assigned. This setting is done using the CDU configuration tool or directly on the device menu.

Supported protocols: MODBUS TCP / IP and BACNet IP

## 2.7 Operation

The device can be configured and run directly using the integrated display and buttons. The Configuration and Diagnostic Software (CDU) for Windows provides additional features, such as selective addressing for slaves.

Depending on the type of modulation, the BKN230-24-PL query takes between 40ms and 100ms, resulting in a typical cycle time between 2.6s and 6.4s for 64 slaves. This cycle time is displayed on the main computer's LCD. If the communication module does not receive any control signals from the central control unit within the set time, it will cause the actuator to move to the safety position "Close".

After a certain amount of time, the menu will lock. You can unlock it by pressing of the BACK / MENU button, for more than 10s. Any changes to the settings will take effect only after the central control unit has been restarted. When the device is ready for use, the following content is displayed:

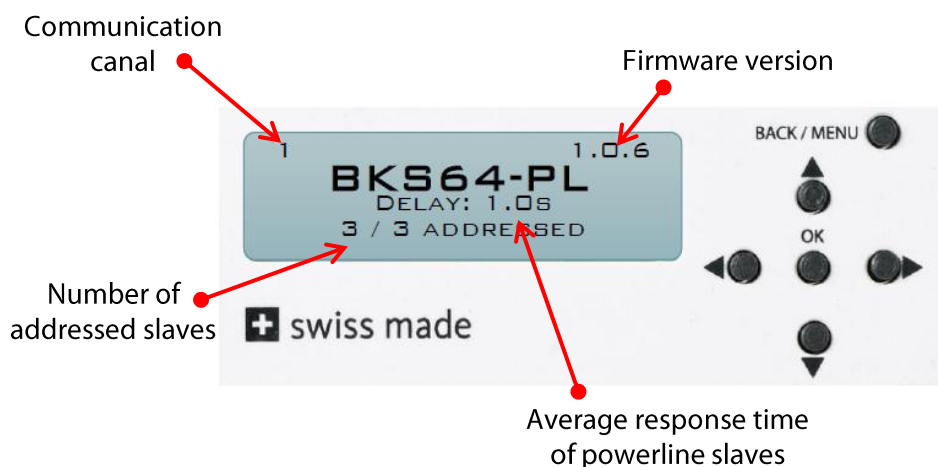

## 2.8 Configuration and diagnostic software CDU

The device can be easily configured through the CDU software, which provides an overview of hardware inputs and outputs, and a list of all slaves and their status. The most important feature is selective addressing of slaves, which can be invoked through the Tools directory -> Slave Addressing. BUS identifiers are assigned randomly. They can be changed in the top "Slaves to address" list, where unallocated communication modules are displayed. They can be set to the appropriate address with the help of "drag and drop" and individual communication modules can be renamed for better orientation.

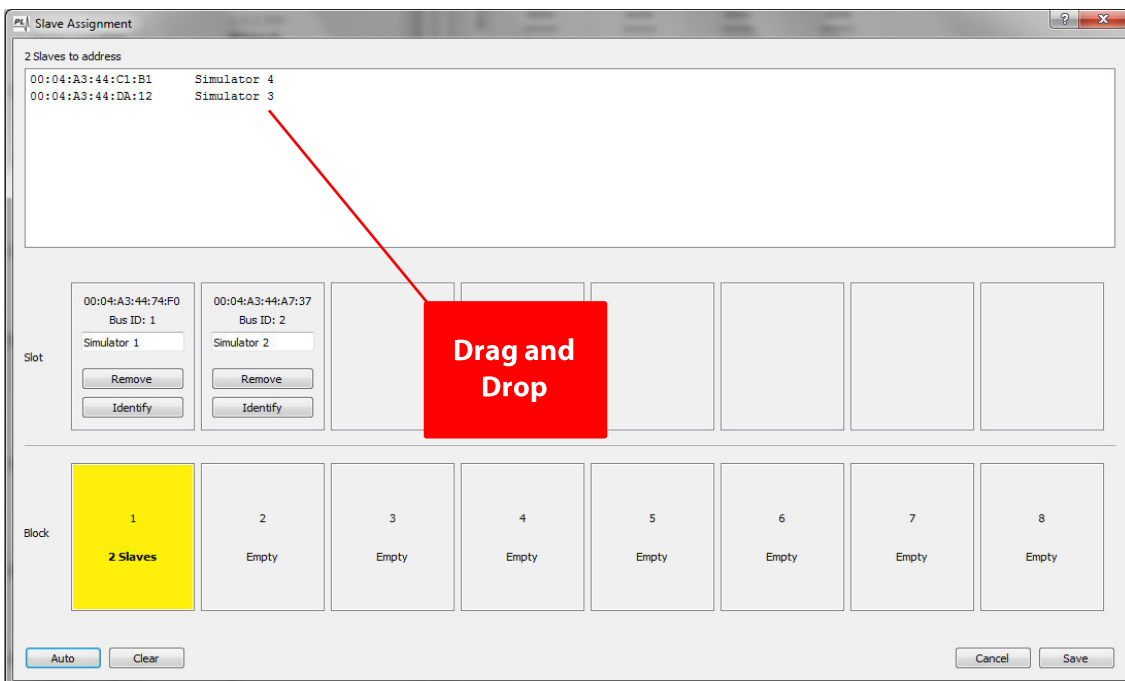
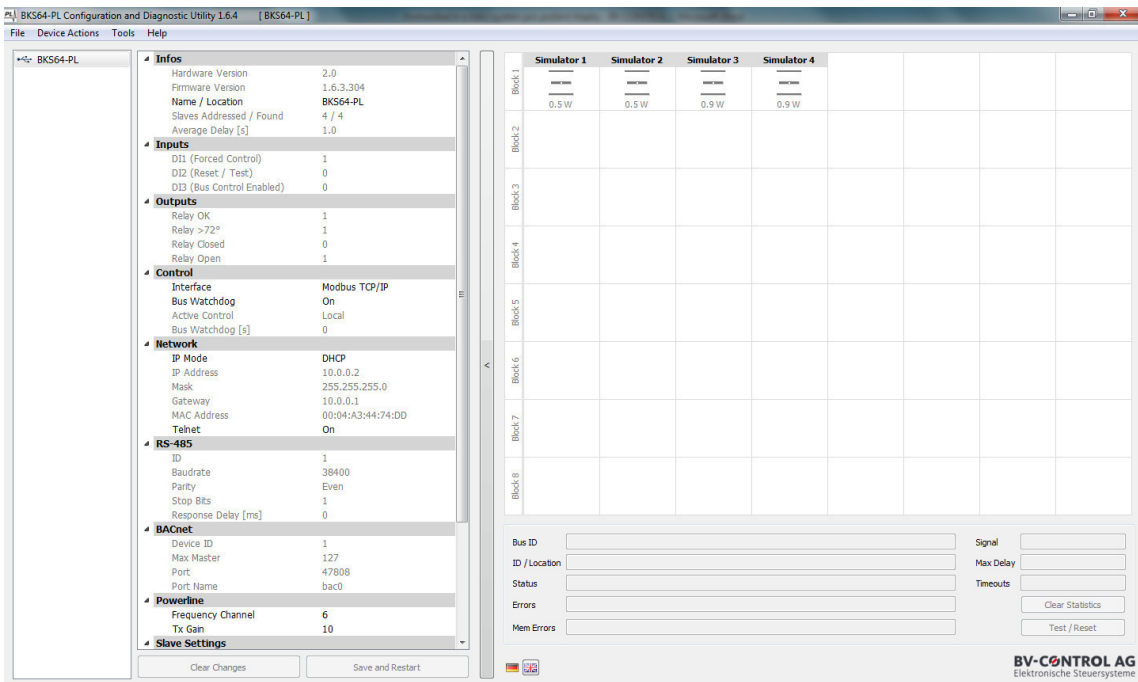

## 2.8.1 Event-logging

Another useful feature is located in the Tools -> Evens directory, in this window we can see the log of all event. These protocols can be saved and exported to pdf. files.

The screenshot shows the 'Events' window with the following settings:

- Devices:**  All,  Master,  Slave Block 1,  Single Slave 1,  Slave List e.g. 1-4, 7, 25
- Event Types:**  All,  Commands,  Errors,  Connection,  Position,  Master Inputs,  Master Relays,  Master Notifications
- Time Range:**  All, From 13.6.2018 0:00, Duration 1d 0h, Today, Last 7 Days, Last 30 Days
- Max Events:** 30
- Search:** [Search]

Date	Time	Device	Type	Message
13.06.2018	09:03:19	Master	Relays	All Open: On
13.06.2018	09:03:20	Master	Notification	Block 1 Open
13.06.2018	09:06:52	Slave 3	Error	+ORS
13.06.2018	09:06:52	Slave 3	Position	Open, Closing
13.06.2018	09:06:52	Master	Relays	OK: Off, >72°: Off
13.06.2018	09:06:52	Master	Notification	Block 1 Error
13.06.2018	09:06:54	Slave 3	Position	Closing
13.06.2018	09:06:54	Master	Relays	All Open: Off
13.06.2018	09:06:54	Master	Notification	Block 1 not Open
13.06.2018	09:07:05	Slave 3	Position	Closed
13.06.2018	09:07:54	Slave 3	Error	-ORS
13.06.2018	09:07:54	Slave 3	Mem Error	+ORS
13.06.2018	09:07:54	Slave 3	Position	Closed, Opening
13.06.2018	09:07:54	Master	Relays	OK: On, >72°: On
13.06.2018	09:07:54	Master	Notification	Block 1 no Error
13.06.2018	09:08:02	Slave 3	Position	Opening
13.06.2018	09:08:48	Slave 3	Position	Open
13.06.2018	09:08:48	Master	Relays	All Open: On
13.06.2018	09:08:48	Master	Notification	Block 1 Open

Buttons: Load, Save, Export. Status: 30 Events

## 2.9 Commissioning

Factory setting disables Powerline communication. This is displayed with the number 0 in the upper left corner of the LCD.

If a search query, including a channel selection, is executed through a CDU or directly on device, the master searches for the connected slaves when restarted.

The search also includes checking the slave software update and if necessary, actualization. This process may take several minutes, depending on the connection quality.

The master recognizes slaves by a unique MAC address regardless of whether they are pre-addressed (e.g., directly by the BKN tool) or not. Without BUS-ID, slaves are not integrated into the control unit, they are not displayed on the LCD, they do not affect the logic of the relay and cannot be interrogated via the bus. Duplicate BUS IDs are recognized by the master and reset to 0.

If slaves without an address are present, they can be automatically addressed via the menu. This should be done only if addressing does not matter. If not, you can selectively address through CDU. The basis is the electrical planning and installation list in which the corresponding MAC addresses are stored. If no list has been created, the selected MAC address in the CDU can be selected by pressing the button.

Once all slaves have been found and addressed, this must be confirmed with "OK" button. This will complete the setting. If all slaves have not been found, a new search must be started.

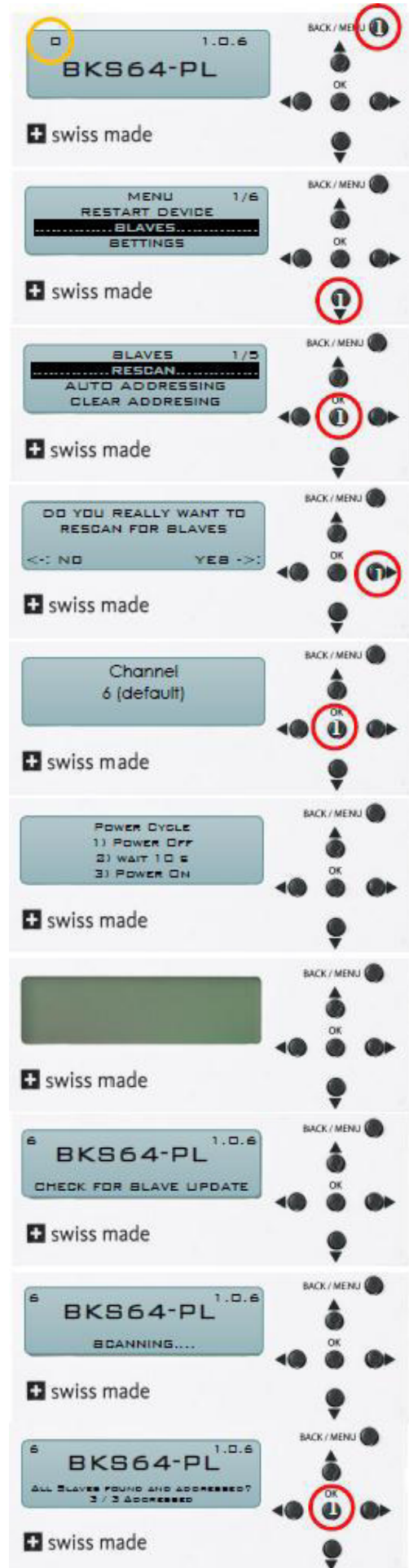

## 2.10 Automatic addressing

Only when the communication module is connected (it has a unique ID BUS), it is displayed on the display and can be controlled. Using the menu, addressing can be done automatically.

At the central control module, only the addressable communication modules appear on the matrix LEDs at the corresponding positions.

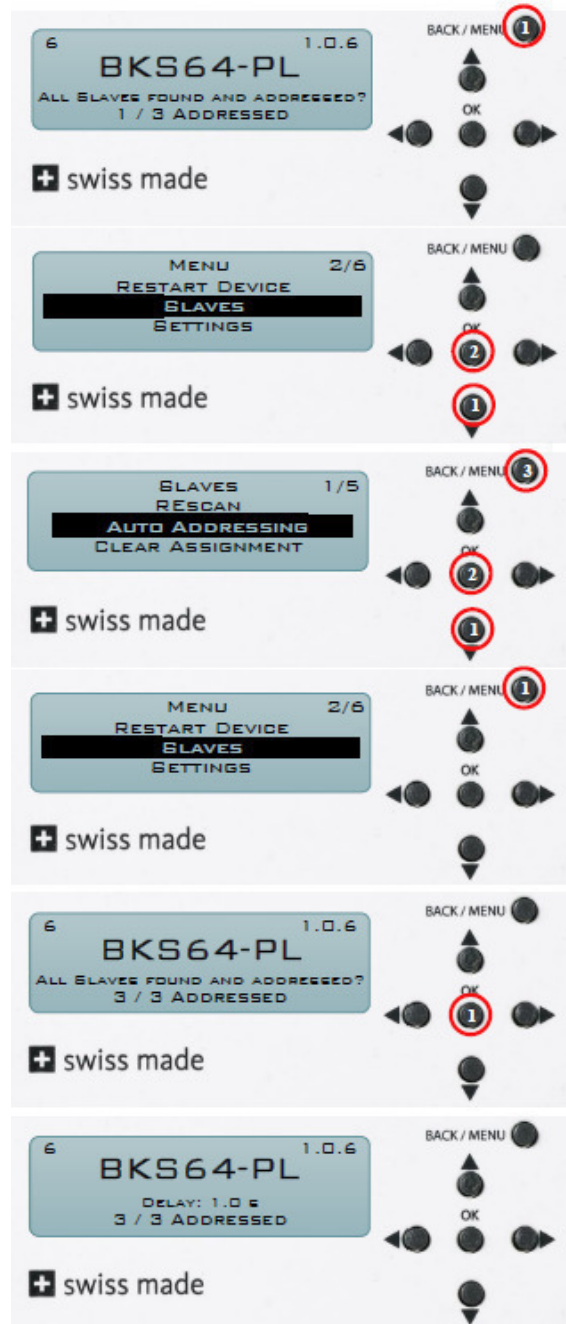

## 2.11 Testing and indication of the dampers

To test a damper, it must first be selected by selecting BLOCK SELECT and SLAVE SELECT. An illustrative example is the damper test with BUS-ID 12.

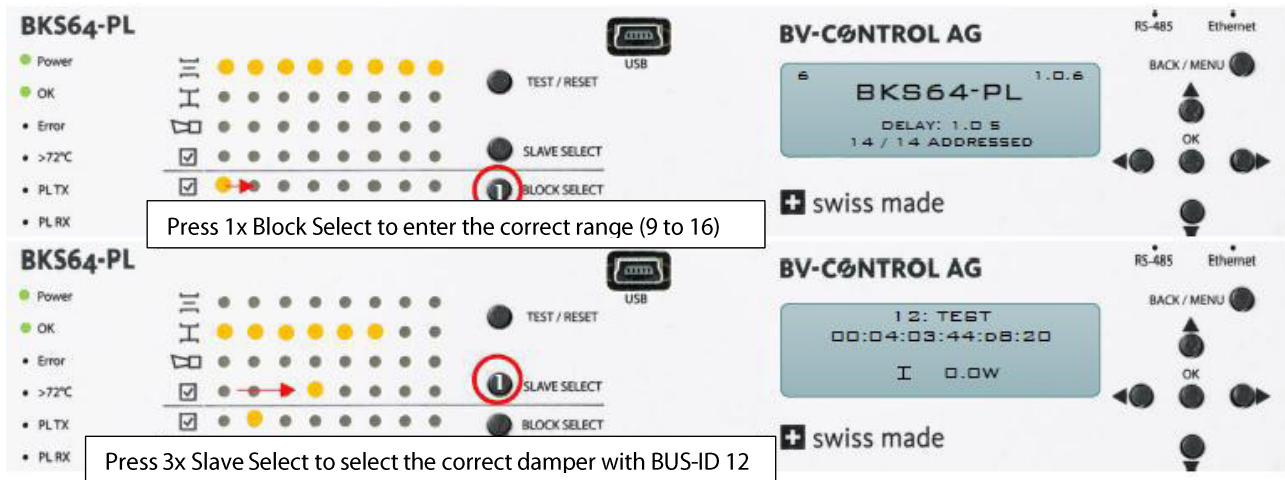

If the flap is selected, the LCD will state its status including energy consumption. By pressing TEST / RESET button you can confirm errors or run auto-test. If the damper reports an error, it is indicated by the corresponding LED in the currently selected block, the corresponding block blinks red. To find an error, first go to the block and select the appropriate damper.

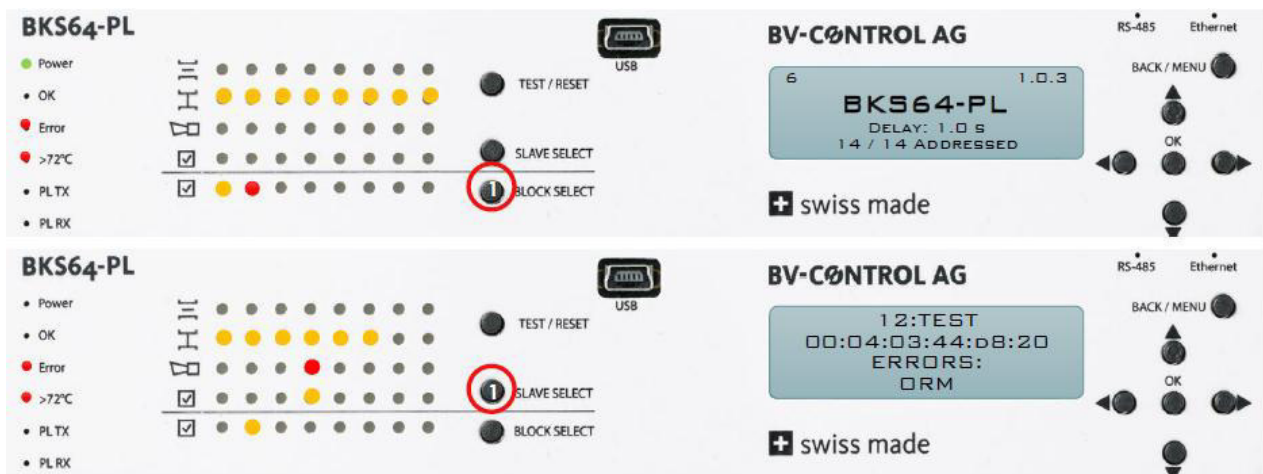



## 2.12 Selecting an interface

The device can be controlled by MODBUS (RTU and TCP / IP) protocol. The example below shows how the MODBUS RTU is selected as a bus interface. Network settings need to be customized only when the CDU is connected via a TELNET network or if the communication is via the MODBUS TCP / IP protocol. For example, to assign a static IP address, the IP mode must first be set to Static.

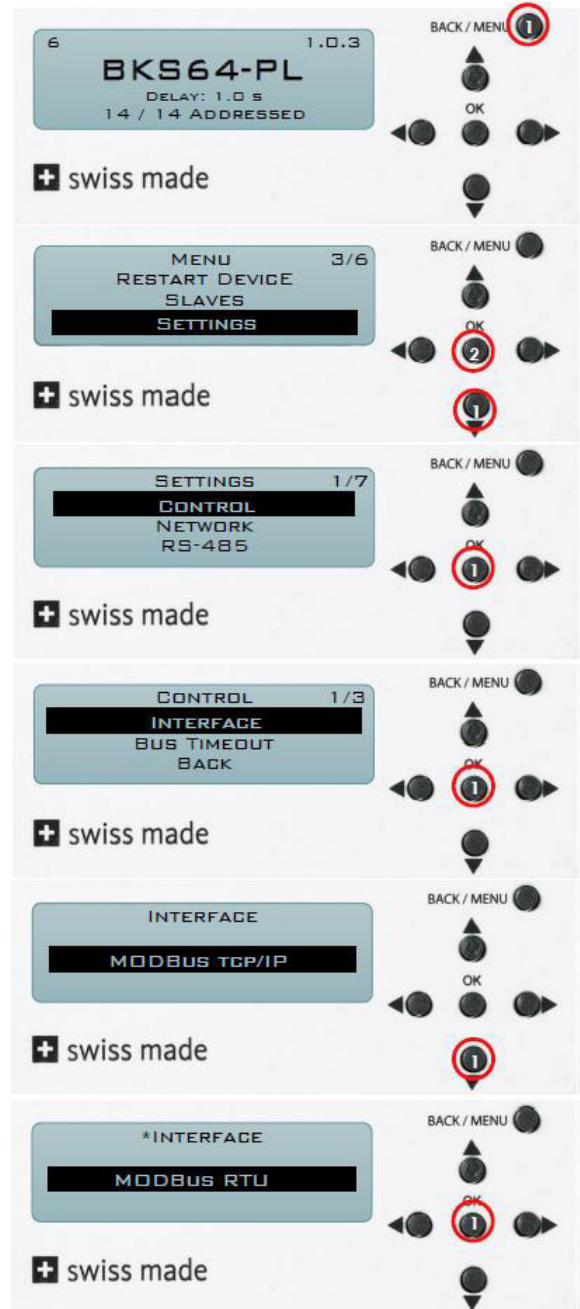
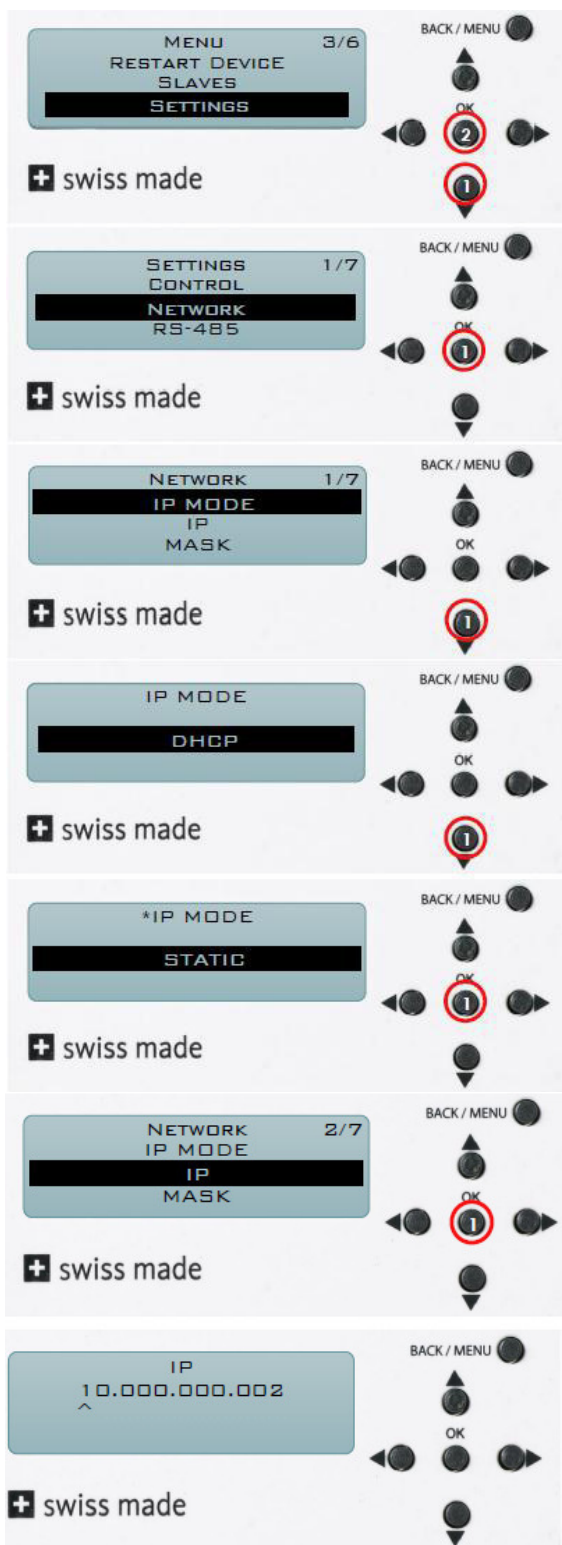

### 3. Communication module BKN230-24-PL

The BKN230-24-PL communication module serves as a communication and power supply for one motorized fire damper with convention 24V actuator. It also has terminals for connecting a smoke detector and a USB interface for updating the software (it can be updated via powerline). With the test button, you can test if the damper reaches both end positions in time, and can also measure power consumption. Communication with the central control unit (BKS64-PL) is done via powerline technology; communication with the slaves is performed directly via 230V AC power cable. Powerline slaves (BKN230-24-PL) have a unique physical MAC address and are always recognized by the master, regardless of pre-or automatic addressing.



## 3.1 Technical parameters

<b>Electrical parameters</b>	Nominal voltage	100-240 V AC, 50/60 Hz
	Power consumption	8 W
	Power supply for actuator and smoke detector	24 V DC / max. 700 mA
	Dimensioning	20 VA
<b>Connection</b>	230V AC powerline	4x Spring connector (2 x L + 2 x N) „Daisy-Chain“ possible
	Smoke detector	Spring connectors (GND, +24 V, IN)
	Actuator	3- a 6pole AMP connector 4pole AMP connector
	USB interface	Mini-USB
<b>Powerline communication</b>	Frequency	Frequency 1: 9-250 kHz Frequency 2: 9-250 kHz
	Modulation	PSK
	Baud rate	Max. 28,8 kbit/s
	Reception sensitivity	Max. 36 dB $\mu$ V
	Bus-detection	Automatic via MAC-address
	Addressing	Manual via USB, automatic or manual via master
<b>Filter powerline</b>	Max. distance from master to BKS	Range: max. 1200 m from start to end
	Damping	> 100 dB at 100 kHz
<b>Security</b>	Class of protection	II
	EMC Low Voltage Directive	CE according to 2014/30/EU CE according to 2014/35/EU
	Operation	Type 1 (EN 30730-1)
	Ambient temperature	-30°C to +50°C
	Storage temperature	-30°C to +80°C
	Humidity test	95%, non-condensing (EN 60730-1)
	Maintenance	Maintenance free
<b>Mechanical parameters</b>	Width	88 mm
	Height	153 mm
	Depth	54 mm
	Weight	290 g
	Mounting	Screw
<b>Power consumption measurement</b>	Accuracy	3 % of the measured value
	Resolution	0,1 W

## 3.2 Cable specification

The maximum distance from the central control unit to the farthest communication module is 1200 m. When connecting to 32 slaves, a cable with a cross section 1.5 mm<sup>2</sup> may be used, if the number of connected slaves is more than 32, a cable with a cross section of 2.5 mm<sup>2</sup> is used. 230V AC power cables should not be led, if possible, in parallel with other power cables, causing too much interference. If this cannot be avoided, by changing the channel it is possible to eliminate all the errors. Each unshielded cable emits a mixture of interference, which is transmitted to other interconnecting cables and sensitive circuits. The use of shielded installation cables can also prevent any interference. The cable design minimizes the radiation and penetration of both electrical and magnetic fields, protecting the environment against cable radiation and preventing intrusion from the surrounding area into the cable.

The terminal marked as X200 is used to connect the power supply, because the system operates on the powerline principle it also serves for communication. When plugging in, the easy-to-install "Daisy chain" principle can be used. **The correct wiring is very important in regards to the 230 V power supply! The polarity, phase to phase and com to com, must be respected when connecting to the power supply network!** All connections have to be fixed before putting power to the devices. **Beside the risk of electrical shock, it is also possible to destroy communication module when not proper handled.**

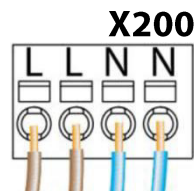

## 3.3 Dimensions

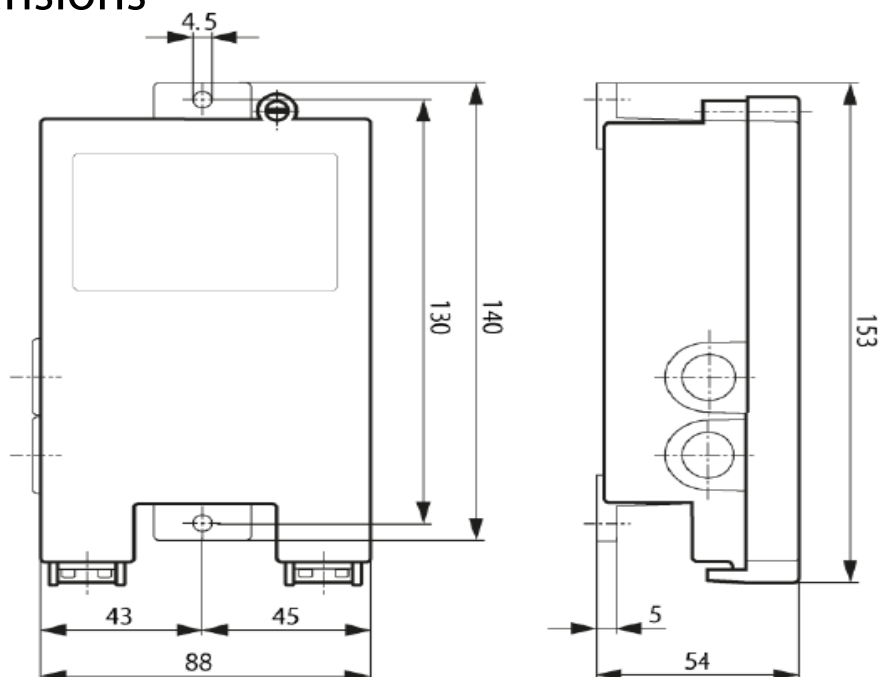

### 3.4 Device description

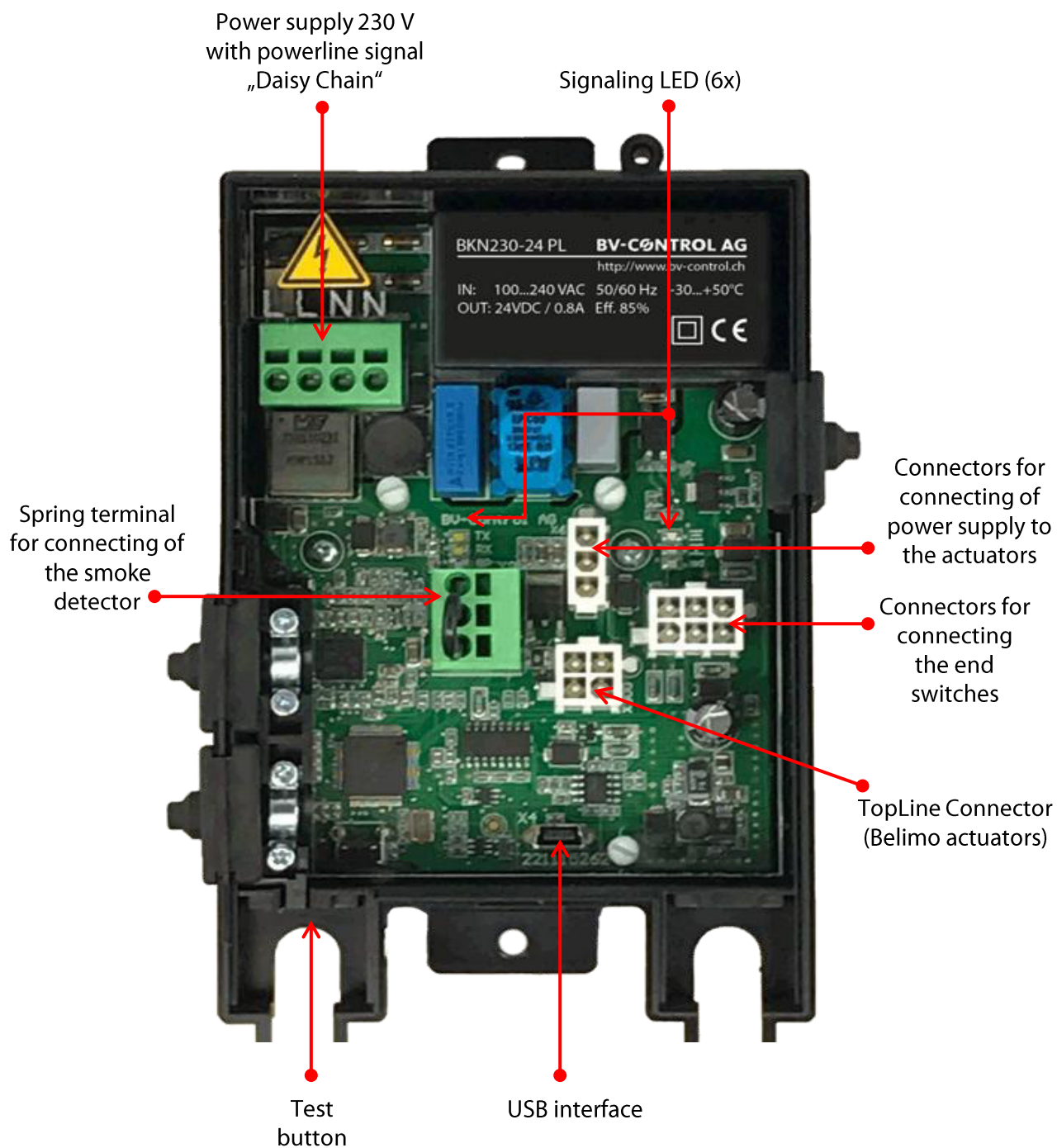

### 3.5 LED indication

LED	Color	Action	Description
Damper position	Green	Flashes	Damper is opening
		Shines	Damper open
Damper position	Yellow	Flashes	Damper is closing
		Shines	Damper closed
Error	Red	Flashes	Error report
		Shines	Error saved
Communication	White Tx	Flashes	Transmission data
Communication	White Rx	Flashes	Receive data
Identification	Blue	Flashes	The device is ready to update the software
		Shines	Identification through master

### 3.6 Test button

The test button has several functions. A short press of a button clears all the stored errors from the device. By using the button, you can check whether the actuator reaches both end positions at the specified time, if the time is exceeded, the damper moves to the safety position and the error message is sent. The pressed button is recognized by the superior system, this makes identification easier. The BKN230-24-PL can also measure the power consumption, if it is higher than the set value, the damper moves to the safety position and the error message is sent. Threshold values for run time of the damper and power consumption can be set on master device BKS64-PL or by CDU software.

### 3.7 Error list

Any errors are indicated by a red LED. The exact cause of the error can be found in the superior system or on the connected computer in the CDU software. The following errors are available:

Error	Description	Repair
INIT	Run-time error	Check and restore the connection
ORM	+24 V is not connected	Check smoke detector
Mechanical error	Damper did not reach the end positions in time	Check damper and end switches
Excessive current	Current actuator power consumption is too high	Mechanically check the damper
No load	No actuator connected	Check connection and BAE
Connection with actuator lost	Top-Line connection with actuator lost	Check Top-Line connection

### 3.8 Smoke detector

Hekatron ORS 142: The device allows the connection of one smoke detector.

- +24V (green cable) must be connected to the contacts 1 a 4
- GND (brown cable) must be connected to the contact 2
- IN (yellow cable) must be connected to the contacts 5

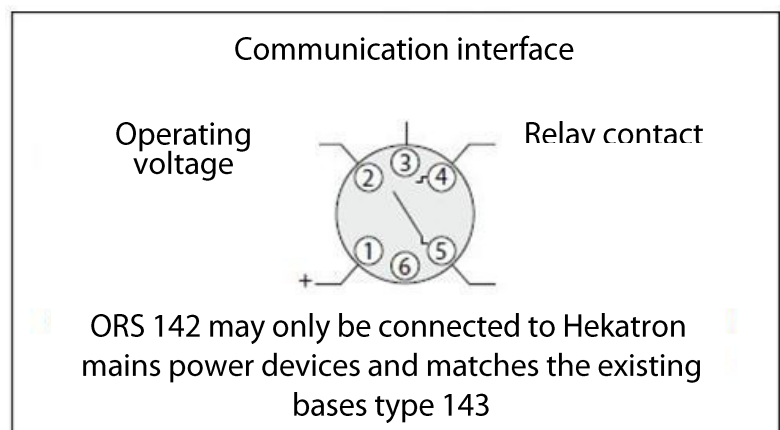
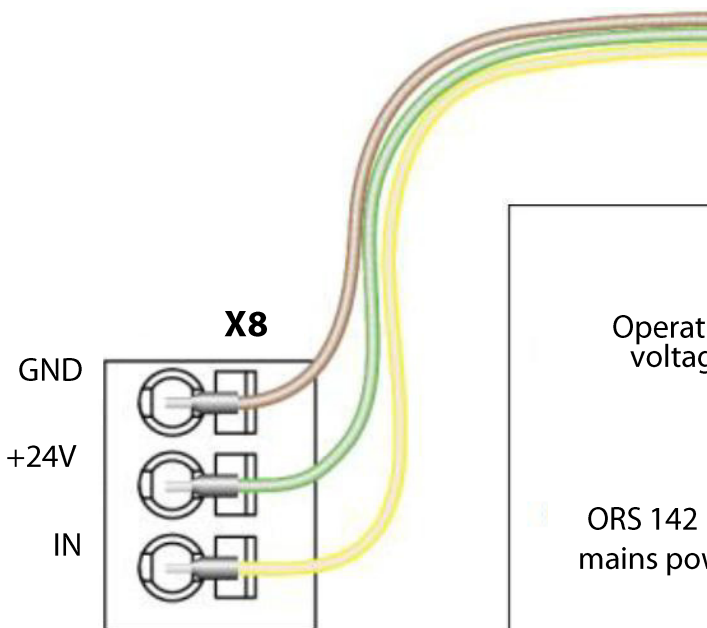

## 4. Safety instructions

The BKS64-PL and BKN230-24-PL devices are intended for use in permanent heating, ventilation and air-conditioning systems and must not be used for applications outside the specified application area. The installation and connection of the 230 V AC must only be carried out by an authorized employee, the legal and official regulations must be observed. The devices must not be disposed of in household waste.





MANDÍK, a.s.  
Dobříšská 550  
26724 Hostomice  
Česká republika  
Tel.: +420 311 706 706  
E-Mail: [mandik@mandik.cz](mailto:mandik@mandik.cz)  
[www.mandik.cz](http://www.mandik.cz)

---

The producer reserves the right for innovations of the product. For actual product information see  
[www.mandik.com](http://www.mandik.com)